



49 Bespoke Inc.
51 Caldari Road, Units 6-7B
Concord, ON L4K 4G3, Canada
Telephone: +1.866.827.4548
Fax: +1.877.731.7745
E-Mail: 49@49bespoke.com
www.49bespoke.com

Distributor Name: _____

Contact Name: _____

Address: _____

Postcode: _____

Country: _____

Telephone: _____

Email: _____

Purchase Order No: _____

Delivery Address: _____

Postcode: _____

Contact Name: _____

Telephone: _____

Email: _____

Notes/Comments:

Do Not Use for Specification Information

Do Not Use for Specification Information

FOR RGK OFFICE USE ONLY

Distributor: _____

A/C No: _____

Net Value: \$ _____

Freight: \$ _____

Invoice Value: \$ _____

Payment Received: \$ _____

	Who	Date
OK to Quote:		
OK to Confirm:		
Document No:	DOC	

- Base product
- Standard configuration
- Mandatory information
- Option with no extra cost
- Information required for option
- Option with extra cost

SBTXZ010 OCTANE SUB4
\$ 10,500.00

XA070 Open design

Max User Weight 110kg

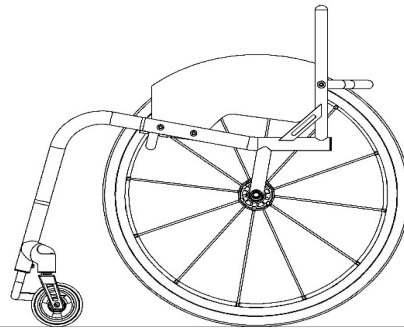

XW010 CAD drawing for approval
NC

KEY FRAME MEASUREMENTS

XY010 Seat width (*Inside of sideguards*)

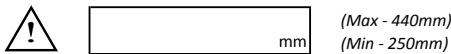

XY020 Seat length

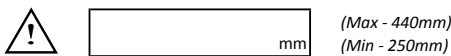

XY030 Extra seat length (*Provides additional leg support & hand grip*)

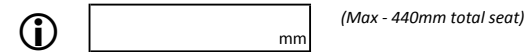

XY050 Front frame height

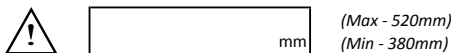

XY060 Rear frame height

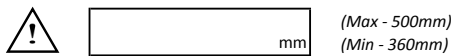

XY070 Frame length



XY072 Caster position



Optimize measurements

XA020 Ergonomic seat
\$ 96.00

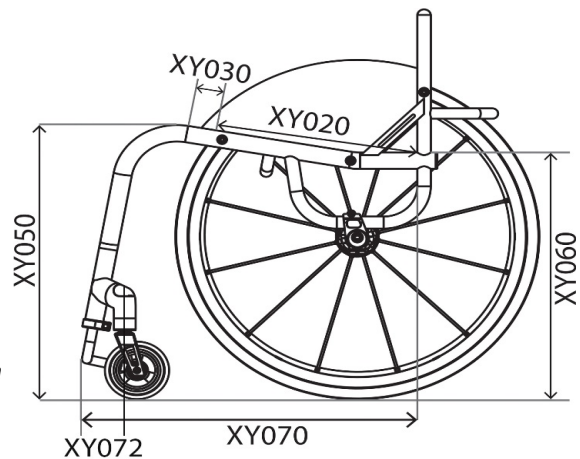
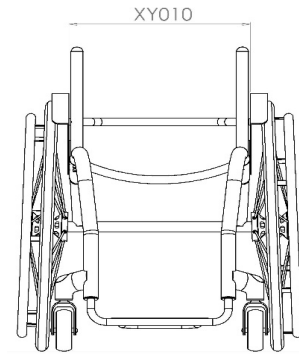
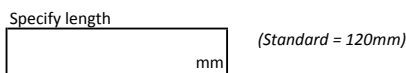

FRONT FRAME AND FOOTREST

Front Frame Options

- XY080 Seat taper design

i Specify width mm

(When combined with XY091, dimension is inbetween the centre of the main bends)

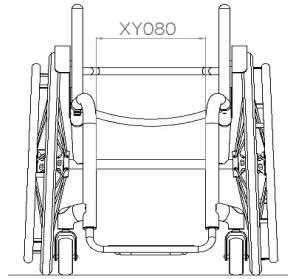

- XY091 Parallel taper design

i Specify width mm

(When combined with XY080, dimensions must be smaller by 20mm)

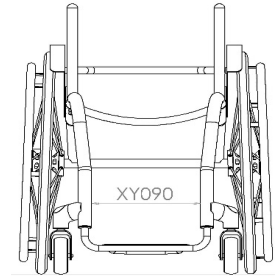

Footrest Design

- XY100 Round design

caster Wheel Size	Max Height Achievable
4"	120

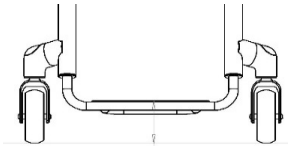

Footrest Measurements

- XY115 Front footrest height

! mm

- XY120 Rear footrest height

i mm

(Std = 20 lower than front height)

- XY125 Footrest length

i mm

Maximum length 140mm

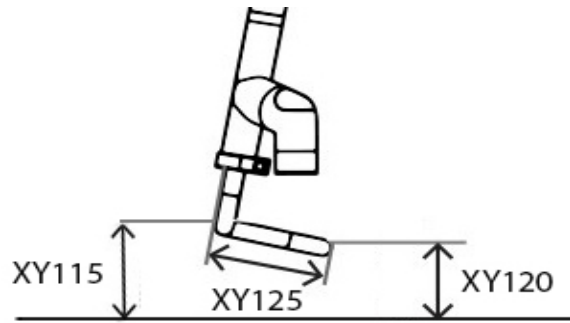

Footrest Style

- XB010 Tubular aluminium footrest
(Height adjustable)

- XB020 Tubular titanium footrest
(Height adjustable)
(*Non-certified option*)

Footrest Cover

- XB045 Lightweight carbon fibre cover
(With weight saving cut-out)

CASTER WHEELS, FORKS & WHEEL LOCKS

Caster Wheels

- XC135 Frog legs aluminium centre 4"x1.25"
Choose colour below:



- | | |
|--|---|
| <input type="checkbox"/> Silver hub & black tire (Std) | <input type="checkbox"/> Green hub & black tire |
| <input type="checkbox"/> Black hub & black tire | <input type="checkbox"/> Red hub & black tire |
| <input type="checkbox"/> Purple hub & black tire | <input type="checkbox"/> Blue hub & black tire |

- SBTXC137 Frog Legs carbon composite centre 4"x1.25" (Black hub & black urethane tire)

NEW!

Caster Forks

- XC190 Low ride caster fork



- Black Silver

Caster Pin Width

- XY330 Caster pin width

- Optimize measurements
(Minimum width for clear caster rotation and maximum wheelbase length)

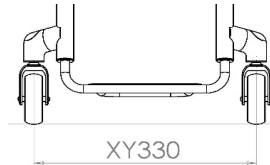

Wheel Lock Options

- SBTXD036 Compact scissor with lightweight fixing XD010 Omit wheel locks

SIDEGUARDS

Sideguard without Fender

- XE055 Screw on lightweight carbon fibre

Sideguard Measurements

- Individual above tire (Follow tire - max. 25mm)



- Level with tire (Follow tire)

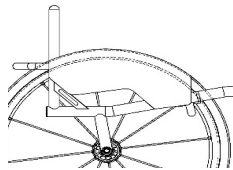

Sideguard with Fender

- XE065 Screw on lightweight carbon fibre with fender

Sideguard Measurements

- 10mm above tire (Standard)

- Individual above tire (Min = 10mm)



- Centre of tire

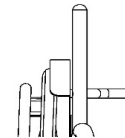
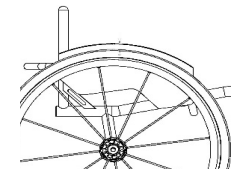

BACKREST

Backrest Height - Fixed

XY230 Fixed backrest height

Specify height

mm

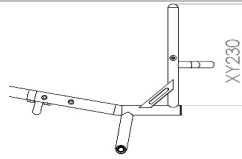

Ergonomics - Rearward Positioning (Choose One)

XY360 Backrest angle

-5 -3 0 +3 +5

Individual Deg
(Max -10/+20 Deg)

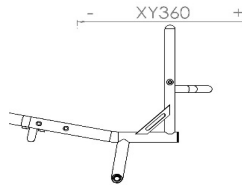

XG100 Ergonomic backrest
\$ 116.00

Vertical height (Min 250mm)

mm

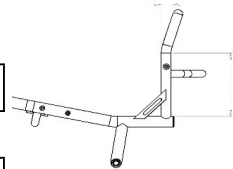

Rearward position

mm



Ergonomics - Lateral Positioning (Choose One)

XG110 Inward taper
\$ 116.00
(inside of backrest posts)

Width mm

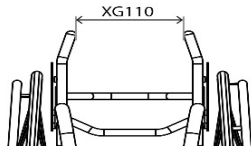

XG120 Outward flare
\$ 116.00
(inside of backrest posts)

Width mm

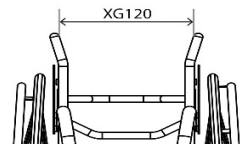

CAMBER BAR

Camber Angle

XY390 Camber angle

1 2 3



Centre of Gravity

SBTXH100 Single post fixed centre of gravity
(25-125mm)

mm

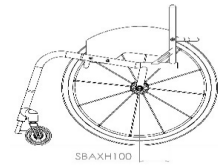

FRAME FINISH OPTIONS

Frame and Footrest

SBTXN030 Brushed frame

SBTXN050 Polished frame

Accent Colour (Choose One)

Finish accent colour black

Finish accent colour red

Finish accent colour purple

Finish accent colour silver

Finish accent colour blue

*Note - Accent includes decal on frame only.

UPHOLSTERY

Seat Upholstery

XP045 Seat sling Sub4 adjustable tension

Backrest Upholstery

XP035 Airtech Sub4 backrest strap adjustable

Backrest Upholstery Stitching Options

Silver (Standard if not indicated)

Red

Black

Light blue

Blue

Purple

Other Upholstery

XS065 Sub4 Calf Strap

REAR WHEELS (* non certified weight options)

Wheel Size

- XY420 Wheel size 24" XY430 Wheel size 25"

Wheel Gap

- XY460 Rear wheel gap

Wheel Options

- XK075 Spinerigy **BLXL** 18 blade spoke *(select colour below - Note: Black hub only)* SBTXK150 Spinerigy **CLX** 18 carbon blade spoke \$ 1,220.00 **NEW!**
- XK225 Titanium 130mm quick release axle pins

Spinerigy Colour Options

- Black spoke / Black hub White spoke / Black hub Purple spoke / Black hub
- Red spoke / Black hub Blue spoke / Black hub XK180 Custom spoke design | \$ 170.00 *(Specify colour)*
- Yellow spoke / Black hub Green spoke / Black hub **Note: Supply picture for custom designs**
- Pink spoke / Black hub Orange spoke / black hub

Handrim Position

- XY480 Narrow set handrim *(Standard if no option selected)* XY485 Wide set handrim
- XL090 Remove excess mounting tabs \$ 116.00 *(recommended for small wheel gaps)*

Handrim Options

- XL010 Aluminium hard anodized 6 tab *(Standard if no option selected)* XL040 Titanium 6 tab \$ 355.00
- XL030 Surge LT 6 tab \$ 499.00 XL050 Stainless steel 6 tab \$ 197.00
- XL020 Tetra grip 6 tab \$ 318.00 RGK-XL140 Ergo gripp 6 tab wide \$ 550.00 **NEW!**
- XL100 Para grip 6 tab \$ 318.00

Tire Options

- XM060 Schwalbe One (Lightest option) \$ 106.00
- XM010 Kenda Grey (Std) Blue Red
- XM130 Kenda black \$ 22.00
- XM020 Schwalbe Marathon Plus \$ 79.00
- XM040 Shox solid airless \$ 128.00 *(24", 25" only)* XM050 Kenda K885 mountain bike tire (24", 25" only) \$ 32.00

Inner Tube Valve Options

- XY500 Schraeder inner tube valve *(Standard if no option selected)* XY490 Presta inner tube valve

* Indicates items that are not part of the certified weight of the Tiga Sub4

CUSHION (** non certified weight options)

Cushion foam options

- XP080 Cushion foam with nylon cover
\$ 96.00 (select density and size below)

Soft (CMS040) Medium (CMS050) Hard (9lb recon)

50mm 75mm 100mm

Cushion cover options

- XP090 Airlite cushion cover
\$ 79.00

- XP100 Upholstery cushion cover upgrade to leather
\$ 202.00

Black (Std) Red Grey

Jay Cushion

- XP250 JAY Extreme Active fluid pad
\$ 1,750.00 (Price subject to change dependant on size)

select size

- XP251 JAY Easy Visco
\$ 650.00 (Price subject to change dependant on size)

select size

Other Jay cushion, please specify code, cost, size and description:

FRAME OPTIONS (** non certified weight options)

- XR060 Welded calf strap mounting loops
\$ 122.00 (To locate calf strap on front frame)

Specify height from floor

Optimize measurements

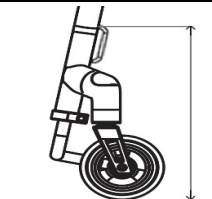

ACCESSORIES (** non certified weight options)

- XR080 Frontwheel assembly
\$ 838.00 (Only with XB010, TGAXB080, XB150)

(Office use only)

Frontwheel serial number:

- XR010 Seat pouch velcro attach (Black)
\$ 47.00

- XR200 Rucksack with RGK logo (Black)
\$ 120.00

- XR020 Underseat large storage bag (Black)
\$ 101.00

- XR090 Tool kit

** indicates options that, when chosen, will not enable RGK to guarantee a Sub4kg product weight

OTHER (** non certified weight options)

Footrest

- XB200 High level footrest
\$ 160.00

Please indicate front footrest height:

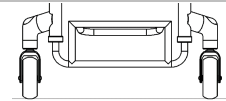
 mm

Caster wheels 3, 4 and 5"

- XC140 Frog Legs aluminium centre 5"x1.4"
\$ 185.00

Wheel Lock Options

- XD020 Underseat scissor XD050 Push to lock

Sideguards

- XE030 Screw on aluminium, indicate size on page 4
\$ 260.00

Backrest Options

- SBTXG020 Folding backrest with 2 position snap lock and angle adjust
\$ 304.00

Push handle Options

- XG070 Screw in push handles \$ 180.00 XG080 Flip down push handles \$ 350.00

Centre of Gravity

- SBTXH130 Square back adjustable centre of gravity \$ 600.00 (25-125mm) SBTXH140 Round back adjustable centre of gravity \$ 600.00 (60-125mm)

Anti-Tip Options

- XJ100 Single sport anti tip \$ 420.00 *(required to change to Adjustable axle)*

Seat Upholstery

- XP040 Seat sling adjustable tension with straps XR050 Carbon fibre seat plate \$ 382.00

Backrest Upholstery

- XP050 Airtech backrest strap adjustable

Backrest Upholstery Leather Options (only with XP050)

- XP070 Backrest upgrade to leather corners \$ 96.00 *(only with Airtech upholstery (XP050), N/A with flip down push handles XG080)*

- Black (Std) Red Grey

Backrest Upholstery Stitching Options (only with XP050)

- Silver *(Standard if not indicated)* Black Blue
 Red Light blue Purple

Backrest Upholstery Logo Options (only with XP050)

- Silver *(Standard if not indicated)* Black Blue
 Red Light blue Purple

Backrest Accessories (only with XP050)

- XP110 Backrest with zip pocket \$ 101.00 XP170 Individual backrest embroidery \$ 160.00 *(Please provide .jpeg file and positioning)*

** indicates options that, when chosen, will not enable RGK to guarantee a Sub4kg product weight



Serial Number: _____

Manufacturing Date: _____/20____



NOTES
