

**AI**  
ALUMINIUM 7020



49 Bespoke Inc.  
137 Buttermill Avenue  
Concord, ON L4K 3X5, Canada  
Tel: +1.866.827.4548



Customer Contact Details

Customer Name: \_\_\_\_\_

Advisor: \_\_\_\_\_

Address: \_\_\_\_\_

\_\_\_\_\_

\_\_\_\_\_

Phone: \_\_\_\_\_

Email: \_\_\_\_\_

Ship to Customer Address:

Shipping Name: \_\_\_\_\_

Shipping Address: \_\_\_\_\_

\_\_\_\_\_

\_\_\_\_\_

Phone: \_\_\_\_\_

Email: \_\_\_\_\_

Additional Information

Notes: \_\_\_\_\_

\_\_\_\_\_

\_\_\_\_\_

\_\_\_\_\_

Current Wheelchair: \_\_\_\_\_

Customer Weight: \_\_\_\_\_

Customer Height: \_\_\_\_\_

Customer Disability: \_\_\_\_\_

Guide:

Base product

Required option

Optional Extra



Critical Information



Information Needed

## PRODUCT STYLE

**GXAX2010 GRAND SLAM X**  
\$11,046.00

Max User Weight 125kg (275lbs)

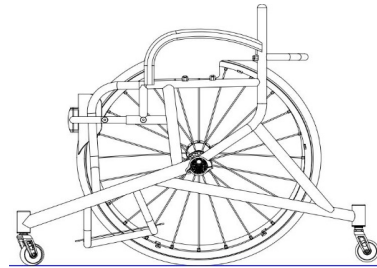

## CAD APPROVAL

XW012 QUOTE CAD drawing for approval  
\$550 FLAT FEE (includes two free revisions)

XW010 ORDER CAD drawing for approval  
\$300 FLAT FEE (includes two free revisions)

XW009 QUOTE only no CAD \$0

XW011 ORDER only no CAD \$0

## KEY MEASUREMENTS

XY010 Seat width (Inside to inside of sideguards)  
  mm (Max - 500mm)

XY020 Seat length  
  mm (Max - 500mm)

XY030 Extra seat length (not required with Knee support)  
  mm

XY050 Front frame height  
  mm (Max - 630mm)  
(Min - 360mm)

XY060 Rear frame height  
  mm (Max - 630mm)  
(Min - 360mm)

XY070 Frame length  
  mm (Min XY020 + XY030 + 110mm)

XA020 Ergonomic seat  
\$116.00  
##  
Specify length  
  mm (Standard = 120mm)

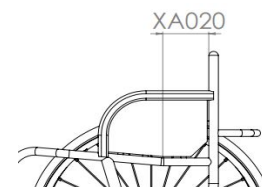
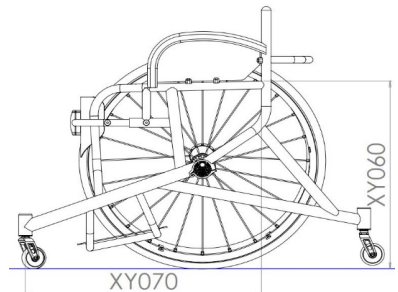
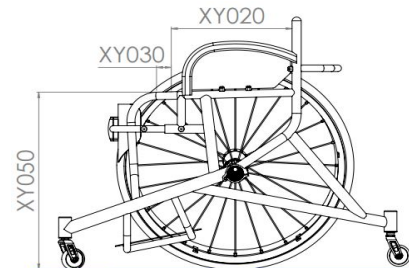
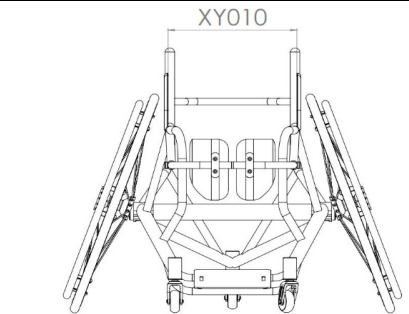

**FRAME OPTIONS**

Front Frame Options (Choose One)

XY080 Seat taper design

**i** Specify taper width  mm

(Optional, to provide additional leg support / positioning)

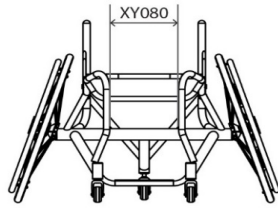

XA130 V-seat design \$295.00

**i** Specify taper width  mm

(Same measurement as XY080)

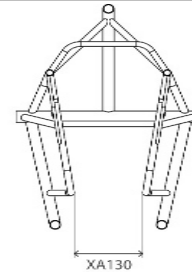

XA136 Frame front seat parallel design \$87.00

**i** Specify width  mm

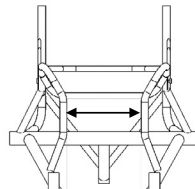

XA131 V-seat and seat taper design \$318.00

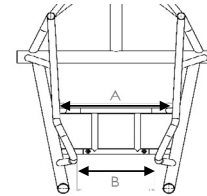

Knee Support Options

XA200 Knee support ratchet system (Tubes on the outside as std)

**i** Specify length  mm

Optimize (Smallest)

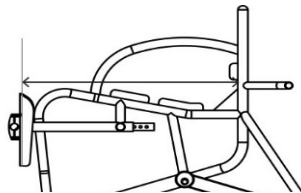

XA202 Plastic shin pads (Includes 5mm padding)

XA203 Carbon fibre shin pads (Includes 7mm hard padding) \$711.00

XA204 Extra padding for shin pads \$174.00

**i** Specify padding thickness  mm

Specify padding density

Medium  Hard

Seat Options

XR040 Aluminum seat plate (riveted to frame) \$185.00

**i** Specify length of plate  mm (Std XY020 - 20mm)

XR050 Carbon fibre seat plate (riveted to frame) \$461.00

**i** Specify length of plate  mm (Std XY020 - 20mm)

**FOOTREST**

Footrest Type

- GXAXB080 Fixed position footrest

Footrest Measurements

<input type="checkbox"/> Front footrest height <input type="text" value=""/> mm (min = 35mm)		<input type="checkbox"/> Footrest width <input type="text" value=""/> mm (Std= 200mm)	
<input type="checkbox"/> Rear footrest height <input type="text" value=""/> mm (min = 35mm)		<input type="checkbox"/> Footrest length <input type="text" value=""/> mm (Std = 250mm)	
<input type="checkbox"/> Footrest position (front of footplate to caster pot) <input type="text" value=""/> mm			

Footrest Plate

<input type="checkbox"/> XB180 Aluminium footplate (2.5mm)	<input type="checkbox"/> GXAXB140 Spacer kit \$80.00 (Allows for 25mm increase in height)
<input type="checkbox"/> XB190 Carbon fibre footplate \$539.00	
<input type="checkbox"/> XB100 ABS moulded foot tray \$176.00 Specify length <input type="text" value=""/> mm (Max = 380mm (Full) Std = 330mm)	

Footrest Plate Options

XB240 Aluminium raised edges  
 (Cost per Edge) \$180.00

Front  
  Back  
  Left  
  Right

Specify height  
 (Max = 60mm)

Caster Pin Width

XY330 Caster pin width  
 mm

Optimize measurements

XY330

## CAMBER BAR, WING AND ANTI-TIP

### Centre of Gravity

GXAXY510 Fixed centre of gravity

Specify measurement

mm

(Note: dimension is taken from front of backrest post to centre of axle)

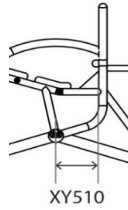

### Camber Angle & Anti Tip

XY390 Camber angle

16  18  20  22

GXAXJ040 Single fixed anti tip



Specify distance behind rear wheel

mm (Std = 100mm)

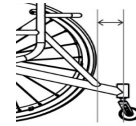

## SIDEGUARDS

### Sideguard Style

GXAXE240 Welded aluminium sport  
\$1,671.00

XE030 Screw on aluminium  
\$314.00

GXAXE230 Welded aluminium sport with Carbon Fibre  
\$1,810.00

XE050 Screw on carbon fibre  
\$698.00

### Sideguard Measurements

Sideguard length

mm

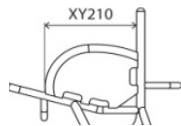

Sideguard height

mm

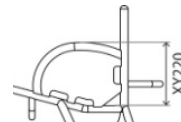

25mm above tire  
(Follow tire)

Individual above tire  
(Follow tire)

mm

Level with tire  
(Follow tire)

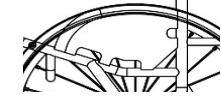
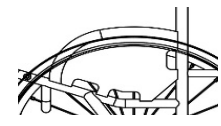

## BACKREST

### Backrest Height (Choose One)

XY230 Fixed backrest height

Specify height

mm

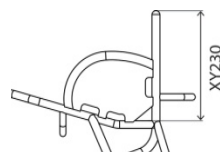

XY245 Adjustable backrest height  
(+/- 25mm)  
\$238.00  
Specify height

mm

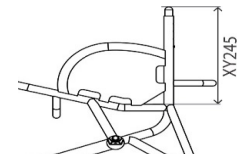

### Ergonomic Options

XY360 Backrest angle

-5  -3  0  +3  +5

Individual  Deg  
(Max -10/+10 Deg)

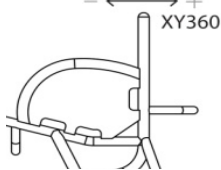

XG100 Ergonomic backrest  
\$140.00

Vertical height

mm

Rearward position

mm

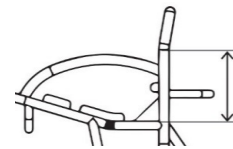

XG110 Inward taper  
(inside of backrest posts)  
\$140.00

Specify width / per side

mm

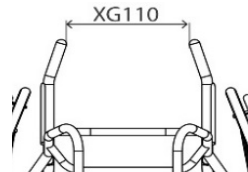

XG120 Outward flare  
(inside of backrest posts)  
\$140.00

Specify width / per side

mm

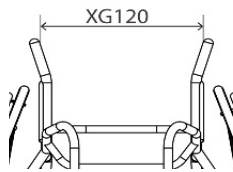

**CASTERS AND REAR WHEELS**

**Caster Options**

- |  |   |
|--|---|
| <input type="checkbox"/> XC160 Sport 61mm caster<br><i>(Std, Black)</i>        | <input type="checkbox"/> XC181 Bones Reds bearings<br><i>(All caster bearings)</i>                      |
| <input type="checkbox"/> XC170 Sport 72mm caster<br>\$192.00<br><i>(Black)</i> | <input type="checkbox"/> XC182 Bones Swiss Ceramic bearings<br>\$578.00<br><i>(All caster bearings)</i> |

**Rear Wheel Size**

- |   |   |   |  |
|---|---|---|--|
| <input type="checkbox"/> XY420 24" Wheels | <input type="checkbox"/> XY430 25" Wheels | <input type="checkbox"/> XY440 26" Wheels | <input type="checkbox"/> XY450 700C Wheels |
|---|---|---|--|

**Rear Wheel Gap**

<input type="checkbox"/> XY460 Rear wheel gap	<input type="checkbox"/> XY470 Inside to inside of wheel
OR	

**Rear Wheel Options**

- |   |  |
|---|--|
| <input type="checkbox"/> XK080 Spinerigy SLX 24 spoke<br>\$967.00 | <input type="checkbox"/> XK100 Spinerigy XSLX 24 spoke<br>\$1,019.00 |
|---|--|

**Spinerigy Colour Options:**



- |  |  |  |   |
|--|--|--|---|
| <input type="checkbox"/> Black spokes  | <input type="checkbox"/> White spokes  | <input type="checkbox"/> Yellow spokes | <input type="checkbox"/> XK180 Individual spoke design<br>\$205.00<br><i>(Specify colour)</i> |
| <input type="checkbox"/> Red spokes    | <input type="checkbox"/> Blue spokes   | <input type="checkbox"/> Pink spokes   | <i>Inside:</i> _____  |
| <input type="checkbox"/> Purple spokes | <input type="checkbox"/> Orange spokes | <input type="checkbox"/> Green spokes  | <i>Outside:</i> _____   |

**Spinerigy Anodise Options**

- |   |  |  |  |
|---|--|--|--|
| <input type="checkbox"/> XK190 Black hub<br>NC<br><i>(std option)</i> | <input type="checkbox"/> XK200 Silver hub<br>\$122.00    | <input type="checkbox"/> XK201 Red hub/rims<br>\$393.00  | <input type="checkbox"/> XK205 Individual hub/rims<br>\$602.00<br>Select colour: _____ |
| <input type="checkbox"/> XK202 Purple hub/rims<br>\$393.00            | <input type="checkbox"/> XK203 Blue hub/rims<br>\$393.00 | <input type="checkbox"/> XK204 Gold hub/rims<br>\$518.00 |  |

**Supply Without Wheels**

- |   |                   |                  |
|---|-------------------|------------------|
| <input type="checkbox"/> XK040 Supply without Wheels<br>-\$234.00 | Wheel Type: _____ | Tire Type: _____ |
|---|-------------------|------------------|

**Handrim Position / Options**

- |   |  |
|---|--|
| <input type="checkbox"/> XY480 Narrow set handrim   | <input type="checkbox"/> XY485 Wide set handrim  |
| <input type="checkbox"/> XL090 Remove excess mounting tabs<br>\$140.00<br><i>(recommended for small wheel gaps)</i> | <input type="checkbox"/> XL080 Super narrow set handrim<br>\$283.00<br><i>(only with XL040 and includes XL090)</i> |

**Handrim Style**

- |   |   |
|---|---|
| <input type="checkbox"/> XL010 Aluminium hard anodized 6 tab<br>\$155.00                                | <input type="checkbox"/> XL040 Titanium 6 tab<br>\$428.00<br><i>(700C not available)</i>  |
| <input type="checkbox"/> XL130 Aluminium hard anodized 6 tab Painted<br>\$155.00                        | <input type="checkbox"/> XL100 Para grip 6 tab<br>\$384.00<br><i>(700C not available)</i> |
| <input type="checkbox"/> XL070 Aluminium hard anodized 12 tab<br>\$140.00<br><i>(24" not available)</i> | <input type="checkbox"/> XL020 Tetra Grip 6 tab<br>\$384.00                               |

**Tire Options**

- |   |  |  |
|---|--|--|
| <input type="checkbox"/> XM070 Kenda Kaliente<br>\$180.00   | <input type="checkbox"/> Red <input type="checkbox"/> Blue | <input type="checkbox"/> XM080 Tufo MS3 tubeless<br>\$78.00<br><i>(Blue only)</i>              |
| <input type="checkbox"/> XM150 IRC Exeracer Pro<br>\$180.00 | <i>(Red Only)</i>  | <input type="checkbox"/> XM090 Tufo WS3 tubeless<br>\$78.00<br><i>(24" only and Blue only)</i> |

**Spare Wheel**

- |   |   |
|---|---|
| <input type="checkbox"/> GXAXK500 Spare wheel Spinerigy<br>\$2171.00<br><i>(All inclusive + axle pin)</i> | <input type="checkbox"/> XK520 Spare wheel Titanium / Super narrow upcharge<br>\$610.00 |
|---|---|

**Inner Tube Valve Options**

- |   |   |
|---|---|
| <input type="checkbox"/> XY500 Schraeder inner tube valve | <input type="checkbox"/> XY490 Presta inner tube valve<br><i>(Standard if no option selected)</i> |
|---|---|

**FINISH OPTIONS**

XN010 Powder coated frame

- | Frame                    | Gloss                  |
|--------------------------|------------------------|
| <input type="checkbox"/> | Black gloss 103        |
| <input type="checkbox"/> | White gloss 100        |
| <input type="checkbox"/> | Grey gloss 132         |
| <input type="checkbox"/> | Cream gloss 135        |
| <input type="checkbox"/> | Red gloss 108          |
| <input type="checkbox"/> | Yellow gloss 120       |
| <input type="checkbox"/> | Forest green gloss 143 |
| <input type="checkbox"/> | Green gloss 107        |
| <input type="checkbox"/> | Dark blue gloss 151    |
| <input type="checkbox"/> | Royal blue gloss 154   |
| <input type="checkbox"/> | Blue gloss 174         |
| <input type="checkbox"/> | Duckegg blue gloss 141 |
| <input type="checkbox"/> | Pink gloss 188         |
| <input type="checkbox"/> | Orange gloss 180       |
| <input type="checkbox"/> | Purple gloss 157       |

- | Frame                    | Matte                |
|--------------------------|----------------------|
| <input type="checkbox"/> | Black matte 105      |
| <input type="checkbox"/> | White matte 101      |
| <input type="checkbox"/> | Grey matte 131       |
| <input type="checkbox"/> | Light grey matte 133 |
| <input type="checkbox"/> | Navy blue matte 152  |

- | Frame                    | Special                  |
|--------------------------|--------------------------|
| <input type="checkbox"/> | Chrome Mirror 300        |
| <input type="checkbox"/> | Sparkle silver 170       |
| <input type="checkbox"/> | Metallic black matte 104 |
| <input type="checkbox"/> | Metallic grey matte 130  |
| <input type="checkbox"/> | Black sandpaper 201      |
| <input type="checkbox"/> | Grey sandpaper 202       |
| <input type="checkbox"/> | White sandpaper 200      |

XN200 Individual paint colour (State Colour/RAL code)  
\$543.00

GXAXN030 Brushed frame  
\$1,304.00

GXAXN050 Polished frame  
\$1,691.00

**Accent Colour (Choose One)**

**Note:** Accent colour includes, forks, castor caps, decals.

- |  |  |   |
|--|--|---|
| <input type="checkbox"/> Black accent  | <input type="checkbox"/> Silver accent                                     | <input type="checkbox"/> XN250 Individual accent<br>\$302.00                    |
| <input type="checkbox"/> Red accent    | <input type="checkbox"/> Blue accent                                       | <input style="width: 100px; height: 20px;" type="text" value="Select Colour:"/> |
| <input type="checkbox"/> Purple accent | <input type="checkbox"/> Carbon accent<br><i>(caps only, others black)</i> |   |

**UPHOLSTERY**

**Seat Upholstery**

GXAXP040 Seat sling strap adjustable *(not required with seatplate)*

**Backrest Upholstery**

GXAXP055 Airtech sport backrest strap adjustable

XP070 Backrest upgrade to leather corners (Black)  
\$116.00

**Backrest Stitching Options**

- |                                 |                                     |                                 |                                 |
|---------------------------------|-------------------------------------|---------------------------------|---------------------------------|
| <input type="checkbox"/> Silver | <input type="checkbox"/> Black      | <input type="checkbox"/> Blue   | <input type="checkbox"/> Orange |
| <input type="checkbox"/> Red    | <input type="checkbox"/> Light blue | <input type="checkbox"/> Purple |                                 |

**Backrest RGK Logo Colour**

- |                                      |                                     |                                 |   |
|--------------------------------------|-------------------------------------|---------------------------------|---|
| <input type="checkbox"/> White (Std) | <input type="checkbox"/> Green      | <input type="checkbox"/> Blue   | <input type="checkbox"/> Individual:<br>_____ |
| <input type="checkbox"/> Red         | <input type="checkbox"/> Light blue | <input type="checkbox"/> Purple |   |

**Backrest Accessories**

XP170 Individual backrest embroidery *(Please provide .jpeg file and positioning)*

**CUSHION**

Cushion Foam Options

- XP080 \$116.00 Cushion foam (select density and size below)
  - Soft (CMS040)
  - Medium (CMS050)
  - Hard (9lb recon)
  - 50mm
  - 75mm
  - 100mm
  - Other
- XP340 \$110.00 Plastazote cushion upgrade (Indicate max height)

Cushion Cover Options

- XP085 Nylon cushion cover (Black)
- XP090 \$95.00 Air Lite cushion cover (Black)
- XP380 \$122.00 Neoprene cushion cover (Black)

**STRAPS**

Velcro straps

- XS050 \$166.00 100mm Pro adjustable velcro strap
- XS055 \$130.00 50mm Pro adjustable velcro strap
- XS057 \$240.00 50mm Pro knee strap (measurement from tube to tube over knees)

Velcro strap position

Strap 1

Specify strap length

Specify distance from back post

Strap 1

Specify strap length

Specify distance from back post

- XS020 \$90.00 Sport ratchet strap (Click strap) (11" x 2" pad)
- XS025 \$390.00 Pelvi Loc 2DA ratchet strap (For thighs and knees)
  - Select size:  Medium (8")  Large (10")
- XS030 \$403.00 Pelvi Loc 3DA ratchet strap (For hips)
  - Select size:  Small (8")  Medium (9")
  - Large (10")  Extra Large (11")
- XS035 \$272.00 M2 ratchet strap (For thighs and knees)
  - 8"  10"  12"

Strap 1

Specify distance from back post

Strap 2

Specify distance from back post

- XS040 \$154.00 Fixed mounting points (one set per click strap)  x1  x2  x3
- XS045 \$93.00 Clamped mounting points (one set per click strap)  x1  x2  x3

**FRAME OPTIONS**

- XR060 \$148.00 Calf strap mounting loops
- XR065 \$113.00 Strap location loops

**ACCESSORIES**

- XR030 \$193.00 Triple wheel bag (Black)
- XP130 \$122.00 Frame protectors full length
- XS100 \$99.00 Bodypoint waist strap  Small  Large
- XS070 Foot strap (select if required)
- XS060 Calf strap (select if required)
- XP400 Back bar protector
- XR090 Tool kit



