



Customer Contact Details

Customer Name: _____

Advisor: _____

Address: _____

Phone: _____

Email: _____

Ship to Customer Address:

Shipping Name: _____

Shipping Address: _____

Phone: _____

Email: _____

Additional Information

Notes: _____

Current Wheelchair: _____

Customer Weight: _____

Customer Height: _____

Customer Disability: _____

Guide:

Base product



Required option



Optional Extra



Critical Information



Information Needed

PRODUCT STYLE

ELAXZ010 ELITE
\$6,700.00

ELAXA062 Standard Frame

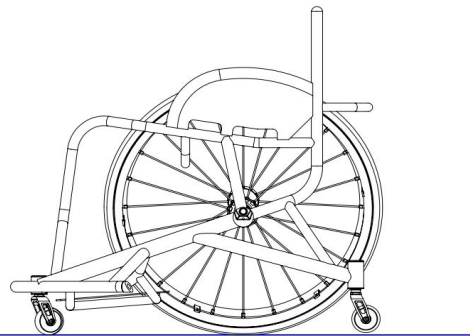

ELAXA063 Standard Frame with 25mm seatrail

 ELAXA280 Heavy Duty Frame
 \$562.00 *(Spinergy R10 wheels also required)*

Max User Weight 125kg (275lbs)

Yes, I am within the max user weight



CAD APPROVAL



XW010 CAD drawing for approval

 XW011
 \$331.00

CAD drawing for approval in 48 hours

KEY MEASUREMENTS

 XY010 Seat width *(Inside to inside of sideguards)*

 mm

(Max - 500mm)

XY020 Seat length

 mm

(Max - 500mm)

 XY030 Extra seat length *(Provides additional leg support & hand grip)*

 mm

XY050 Front frame height

 mm

(Max - 630mm)
(Min - 360mm)

XY060 Rear frame height

 mm

(Max - 630mm)
(Min - 360mm)

XY070 Frame length



 mm

(Min = XY020 + XY030 + 140mm)

 XA020 Ergonomic seat
 \$106.00

Specify length

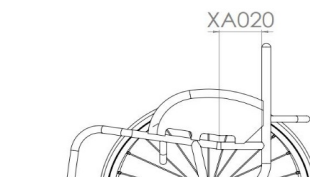
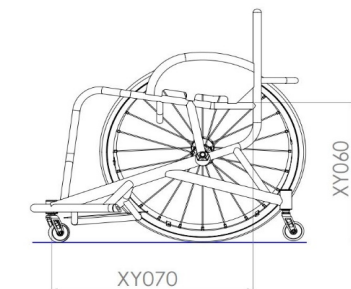
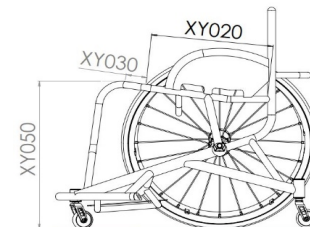
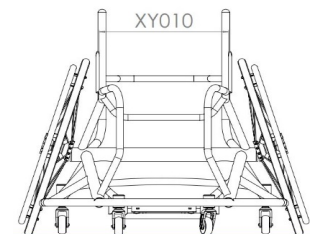
 mm

(Standard = 120mm)

FRONT FRAME AND SEAT

Front Frame Options (Choose One)

XY080 Seat taper design

i Specify taper width mm

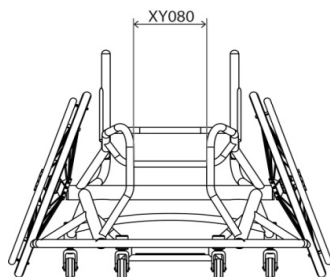

XA130 V-seat design
\$269.00

i Specify taper width mm

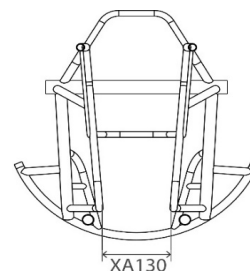

Advanced Front Frame Options

XY082 Seat taper position
\$79.00

i Specify measurement mm

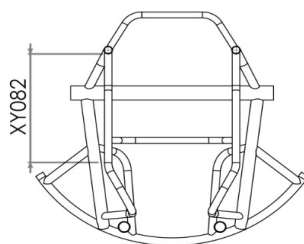

XA131 V-seat and taper design
\$290.00

i Specify inside width at front of sideguard (A) mm

i Specify taper width (B) mm

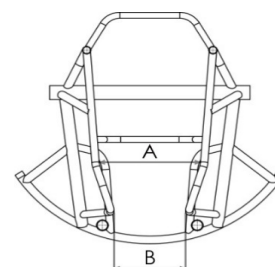

XA136 Parallel taper design
\$79.00
(Not with Seat Taper XY080)

i Specify taper width mm

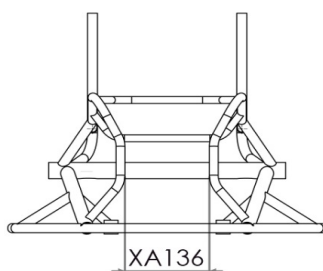

XA135 Asymmetrical taper design
\$233.00

i Specify taper width (A) mm

i Specify offset (B)
(Inside of sideguard to inside of taper width) mm

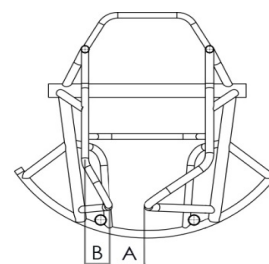

Seat Options

XR040 Aluminum seat plate
\$169.00
(riveted to frame)

i Specify length of plate mm (Std XY020 - 20mm)

XA260 Drop seat design
\$193.00
(only with either XR040 or 050)

i Specify drop mm (Std = 20mm)

XR050 Carbon fibre seat plate
\$421.00
(riveted to frame)

i Specify length of plate mm (Std XY020 - 20mm)

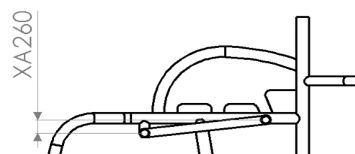

FOOTREST

Fixed Footrest

- ELAXB080 Fixed position footrest

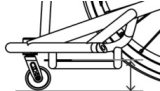
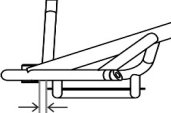

Height and Position

- Front footrest height
 mm (min = 35mm) 
- Rear footrest height
 mm (min = 35mm) 
- Footrest position (front of footplate to castor pot)
 mm 

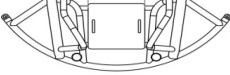
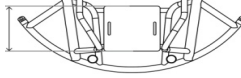
Footrest Size (Not ABS)

- Footrest width
 mm (Std = 200mm) 
- Footrest length
 mm (Std = 250mm) 



Footrest Plate

- XB180 Aluminium footplate (2.5mm)
- XB190 Carbon fibre footplate \$492.00
- XB100 ABS moulded foot tray \$161.00
 Specify length
 mm (Max = 380mm (Full) Std = 330mm) 
- ELAXB140 Spacer kit \$111.00 (Allows for 25mm increase in height)
- ELAXB145 Multi position footrest tubes \$523.00 

Adjustable Footrest

- ELAXB130 Clamp on adjustable position footrest \$269.00 (100mm range)

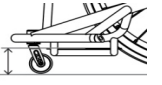
Height and Position

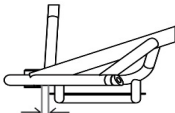
- Front footrest height
 mm (min = 40mm) 
- Rear footrest height
 mm (min = 40mm) 
- Footrest position (front of footplate to castor pot)
 mm 

Footrest Size (Not ABS)

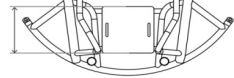
- Footrest width
 mm (Std = 200mm) 
- Footrest length
 mm (Std = 250mm) 



Footrest Plate

- XB180 Aluminium footplate (5mm)
- XB100 ABS moulded foot tray \$161.00
 Specify length
 mm (Max = 380mm (Full) Std = 330mm) 

Footrest Plate Options

- XB240 Aluminium raised edges (Cost per Edge) \$164.00
 Front Back Left Right
 Specify height (Max = 60mm)
- XB250 Carbon Fibre raised edge (1 side only) \$1,185.00
 Front Back
 Specify height (Max = 45mm)

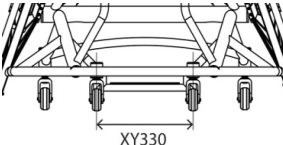
Caster Pin Width

- XY330 Caster pin width 
 mm 
 Optimise measurements

CAMBER BAR, WING AND ANTI-TIP

Centre of Gravity

ELAXY510 Fixed centre of gravity

Specify measurement
 mm

(Note: dimension is taken from front of backrest to centre of axle)

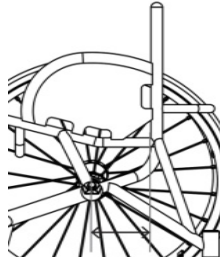

ELAXY515 Backrest COG adjustment
 (Not with welded sides)
 (+/-20mm)

Specify measurement
 mm

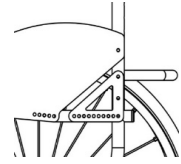

ELAXY560 Adjustable centre of gravity

Specify measurement
 mm

Specify Camber Angle

XY390 Camber angle

16 18 20 22

Wing Options

ELAXA110 Round design basketball wing

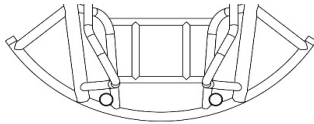

ELAXA125 Arrow design basketball wing
 \$228.00

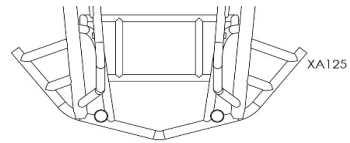

ELAXA120 Straight sided design basketball wing
 \$228.00

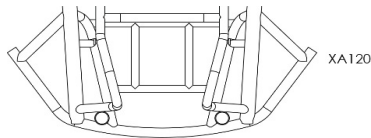

Anti-tip options

ELAXJ040 Single fixed anti tip

ELAXJ060 Double fixed anti tip
 \$315.00
 (With high mount joining bar)

Specify caster pin width
 mm

Optimize measurements
 (Wide as possible - std if not indicated)

SIDEGUARDS

Sideguard Style

- ELAXE230 Welded aluminium sport
\$474.00 *(Not with backrest COG Adj - ELAXY510)*
- ELAXE250 Welded aluminium tubes only
\$223.00 *(Not with backrest COG Adj - ELAXY510)*
- XE310 High design upgrade
\$290.00 *(Only with option ELAXE230)*

- XE030 Screw on aluminium
\$287.00
- XE050 Screw on carbon fibre
\$637.00 *(Not recommended for basketball use)*

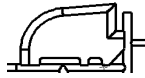

Sideguard Measurements

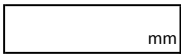
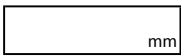
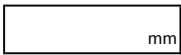
- Sideguard length
 mm
- Sideguard height (back)
 mm
- Sideguard height (front)
(optional for max height players)
 mm

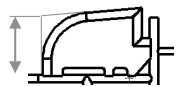
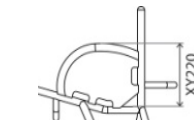
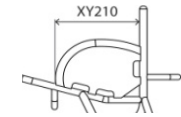

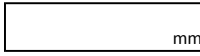
- Follow Tire Design
- 25mm above tire
- Individual above tire
 mm
- Level with tire

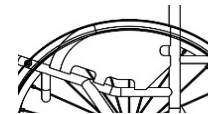
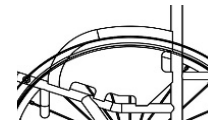

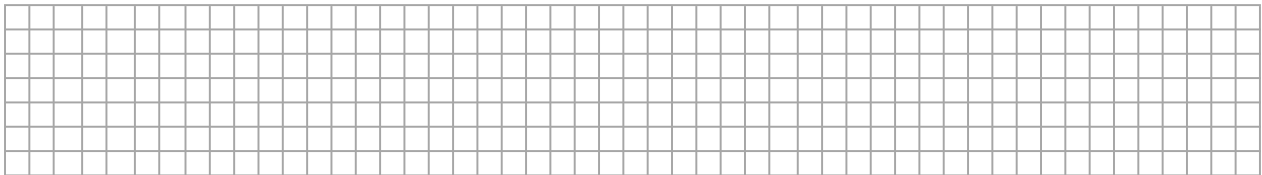

Individual Shape

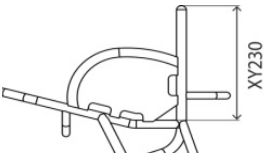

BACKREST

Backrest Height (Choose One)

- XY230 Fixed backrest height
 Specify height
 mm

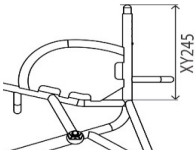
- XY245 Adjustable backrest height
\$217.00 *(+/-25mm)*
 Specify height
 mm

Ergonomic Options

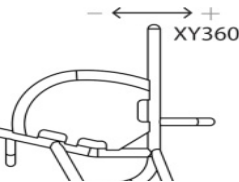
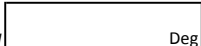
- XY360 Backrest angle
-5 -3 0 +3 +5
 XY360
Individual  Deg
(Max -10/+10 Deg)

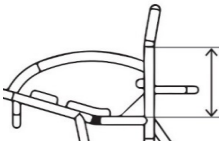
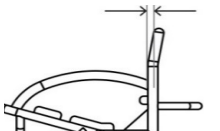
- XG100 Ergonomic backrest
\$128.00
Vertical height  mm
Rearward position  mm

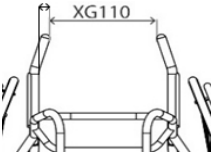
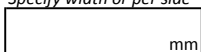
- XG110 Inward taper
\$128.00 *(not with ELAXY245)*
Specify width or per side
 XG110
 mm

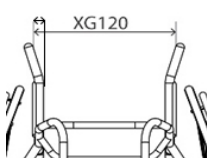
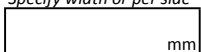
- XG120 Outward flare
\$128.00 *(not with ELAXY245)*
Specify width or per side
 XG120
 mm

CASTORS AND REAR WHEELS

Castor Options

- | | |
|---|--|
| <input checked="" type="checkbox"/> XC160 Sport 61mm castor (Black) | <input type="checkbox"/> XC181 Bones Reds bearings (All castor bearings) |
| <input checked="" type="checkbox"/> XC200 Sport micro fork | <input type="checkbox"/> XC182 Bones Swiss Ceramic bearings (All castor bearings) \$528.00 |

Rear Wheel Size

- | | | | |
|---|---|---|--|
| <input type="checkbox"/> XY420 24" Wheels | <input type="checkbox"/> XY430 25" Wheels | <input type="checkbox"/> XY440 26" Wheels | <input type="checkbox"/> XY450 700C Wheels |
|---|---|---|--|

Rear Wheel Gap

<input type="checkbox"/> XY460 Rear wheel gap	<input type="checkbox"/> XY470 Inside to inside of wheel
---	--

15 20 25 30
 Individual

OR

Rear Wheel Options

- | | |
|--|--|
| <input type="checkbox"/> XK030 Equalizer 36/48 spoke | <input type="checkbox"/> XK330 Spinergy SLX R10 heavy duty 24 spoke (\$1,632.00) (18 deg camber angle only) |
| <input type="checkbox"/> XK080 Spinergy SLX 24 spoke (\$883.00) | |

Spinergy Colour Options:



- | | | |
|--|--|--|
| <input type="checkbox"/> Black spokes | <input type="checkbox"/> White spokes | <input type="checkbox"/> Yellow spokes |
| <input type="checkbox"/> Red spokes | <input type="checkbox"/> Blue spokes | <input type="checkbox"/> Pink spokes |
| <input type="checkbox"/> Purple spokes | <input type="checkbox"/> Orange spokes | <input type="checkbox"/> Green spokes |

- | |
|--|
| <input type="checkbox"/> XK180 Individual spoke design (\$187.00) (Specify colour) |
|--|

Inside: _____

Outside: _____

Spinergy Anodize Options

- | | | | |
|--|---|---|--|
| <input type="checkbox"/> XK190 Black hub (\$106.00) (std option) | <input type="checkbox"/> XK200 Silver hub (\$111.00) | <input type="checkbox"/> XK201 Red hub/rims (\$359.00) | <input type="checkbox"/> XK204 Individual hub/rims (\$473.00) Select colour: _____ |
| <input type="checkbox"/> XK202 Purple hub/rims (\$359.00) | <input type="checkbox"/> XK203 Blue hub/rims (\$359.00) | <input type="checkbox"/> XK204 Gold hub/rims (\$473.00) | |

Supply Without Wheels

- | | | |
|--|---|--|
| <input type="checkbox"/> XK040 Supply without Wheels (-\$234.00) | <input type="checkbox"/> Wheel Type: <input type="text"/> | <input type="checkbox"/> Tire Type: <input type="text"/> |
|--|---|--|

Handrim Position / Options

- | | |
|--|---|
| <input type="checkbox"/> XY480 Narrow set handrim | <input type="checkbox"/> XY485 Wide set handrim |
| <input type="checkbox"/> XL090 Remove excess mounting tabs (\$128.00) (recommended for small wheel gaps) | <input type="checkbox"/> XL080 Super narrow set handrim (\$258.00) (only with XL040 and includes XL090) |

Handrim Style

- | | |
|--|--|
| <input type="checkbox"/> XL010 Aluminium hard anodized 6 tab | <input type="checkbox"/> XL040 Titanium 6 tab (\$391.00) (Not with 700C) |
| <input type="checkbox"/> XL070 Aluminium hard anodized 12 tab (\$128.00) (24" not available) | <input type="checkbox"/> XL050 Stainless steel 6 tab (\$217.00) |

Tire Options

- | | |
|--|---|
| <input type="checkbox"/> XM070 Kenda Kaliente <input type="checkbox"/> Red <input type="checkbox"/> Blue | <input type="checkbox"/> XM080 Tufo MS3 tubeless (\$71.00) (Blue only) |
| <input type="checkbox"/> XM150 IRC Exeracer Pro (\$164.00) (Red Only) | <input type="checkbox"/> XM090 Tufo WS3 tubeless (\$71.00) (24" only and Blue only) |

Spare Wheel

- | | |
|--|---|
| <input type="checkbox"/> ELAXK500 Spare wheel Spinergy (\$1,983.00) (All inclusive + axle pin) | <input type="checkbox"/> XK520 Spare wheel upcharge (\$557.00) (for Titanium or super narrow push rims) |
|--|---|

Inner Tube Valve Options

- | | |
|---|---|
| <input type="checkbox"/> XY500 Schraeder inner tube valve | <input type="checkbox"/> XY490 Presta inner tube valve (\$57.00) (Standard if no option selected) |
|---|---|

FINISH OPTIONS

Frame & Component finish

 XN010 Powder coated frame

 XN150 Powder coated components *(Frame colour if not specified)*

Frame Comp.

Gloss

Frame Comp.

Matt

Frame Comp.

Special
 Black gloss 103

 Black matt 105

 Chrome Mirror 300

 White gloss 100

 White matt 101

 Sparkle silver 170

 Grey gloss 132

 Grey matt 131

 Metallic black matt 104

 Cream gloss 135

 Light grey matt 133

 Metallic grey matt 130

 Red gloss 108

 Navy blue matt 152

 Black sandpaper 201

 Yellow gloss 120

 Grey sandpaper 202

 Forest green gloss 143

 White sandpaper 200

 Green gloss 107

 Dark blue gloss 151

 Royal blue gloss 154

 Blue gloss 174

 Duckegg blue gloss 141

 Pink gloss 188

 Orange gloss 180

 Purple gloss 157

 XN200 Individual paint colour (State Colour/RAL code)
\$496.00

Frame Comp

 ELAXN030 Brushed frame
\$1,191.00
(All parts black unless XN160 chosen)
 XN160 Brushed components
\$106.00
(not required with fixed footrest & backrest)
 ELAXN050 Polished frame
\$1,544.00
(All parts black unless XN170 chosen)
 XN170 Polished components
\$187.00
(not required with fixed footrest & backrest)

Accent Colour

Note: Accent colour includes, forks, castor caps, decals.

 Black accent

 Silver accent

 XN250 Individual accent
\$276.00

 Red accent

 Blue accent

 Purple accent

 Select Colour:

UPHOLSTERY (N/A WITH CX SEAT)

Seat Upholstery

 XP040 Seat sling strap adjustable
(Not required with seat plate)

Backrest Upholstery

 XP055 Airtech sport backrest strap adjustable (BLK)

 XP070 Backrest upgrade to leather corners
\$106.00 *(Black)*

Backrest Stitching Options

 Silver

 Black

 Blue

 Individual: _____

 Red

 Light blue

 Purple

Backrest RGK Logo Colour

 White (Std)

 Green

 Blue

 Individual: _____

 Red

 Light blue

 Purple

Backrest Accessories

 XP170 Individual backrest embroidery
\$176.00
(Please provide .jpeg file and positioning)

CUSHION

Cushion Foam Options

- XP080 Cushion foam (select density and size below) \$106.00
- Soft (CMS040) Medium (CMS050) Hard (9lb recon)
- 50mm 75mm 100mm Other mm
- XP340 Plastazote cushion upgrade (Indicate max height) \$100.00

Cushion Cover Options

- XP081 Nylon cushion cover (Black)
- XP090 Air Lite cushion cover (Black) \$87.00
- XP380 Neoprene cushion cover (Black) \$111.00

STRAPS

Velcro straps

- XS050 100mm Pro adjustable velcro strap \$152.00
- XS055 50mm Pro adjustable velcro strap \$152.00
- XS057 50mm Pro knee strap (measurement from tube to tube over knees) \$152.00

Velcro strap position

Strap 1

Specify strap length mm

Specify distance from back post mm

Strap 1

Specify strap length mm

Specify distance from back post mm

- XS020 Sport ratchet strap (Click strap) (11" x 2" pad) \$82.00

- XS025 Pelvi Loc 2DA ratchet strap (For thighs and knees) \$356.00

- i** Select size: Medium (8") Large (10")

- XS030 Pelvi Loc 3DA ratchet strap (For hips) \$368.00

- i** Select size: Small (8") Medium (9") Large (10") Extra Large (11")

- XS035 M2 ratchet strap (For thighs and knees) \$248.00

- i** 8" 10" 12"

Strap 1

Specify distance from back post mm

Strap 2

Specify distance from back post mm

- XS040 Fixed mounting points (one set per click strap) \$141.00 x1 x2 x3

- XS045 Clamped mounting points (one set per click strap) \$85.00 x1 x2 x3

FRAME OPTIONS

- XR060 Calf strap mounting loops \$135.00



- XR065 Strap location loops \$103.00

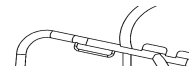

ACCESSORIES

- XR030 Triple wheel bag (Black) \$176.00

- XS070 Foot strap (select if required)

- XP130 Frame protectors full length \$111.00

- XS060 Calf strap (select if required)

- XS100 Bodypoint waist strap \$90.00 Small Large

- XP400 Back bar protector

- XR090 Tool kit

ELITE

SERIAL NO: _____

PROD DATE: ____ / ____

