



Customer Contact Details

<p>Customer Name: _____</p> <p>Advisor: _____</p> <p>Address: _____ _____ _____</p> <p>Phone: _____</p> <p>Email: _____</p>	<p>Ship to Customer Address: <input type="checkbox"/></p> <p>Shipping Name: _____</p> <p>Shipping Address: _____ _____ _____</p> <p>Phone: _____</p> <p>Email: _____</p>
---	--

Additional Information

<p>Notes: _____ _____ _____</p>	<p>Current Wheelchair: _____</p> <p>Customer Weight: _____</p> <p>Customer Height: _____</p> <p>Customer Disability: _____</p>
---	--

Guide:

- Base product
- Required option
- Optional Extra
- Critical Information
- Information Needed

PRODUCT STYLE

HLTXZ010 HI-LITE
\$ 5,299.00

- XA070 Open design
- XA080 Closed design

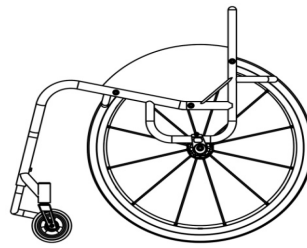

XA070 - Open design

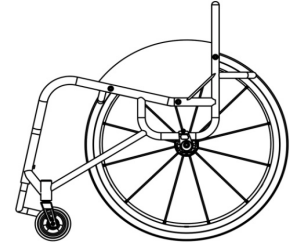

XA080 - Closed design

Max User Weight 125kg (275lbs)

- Yes, I am within the max user weight

CAD APPROVAL

- XW010 CAD drawing for approval
- XW011 CAD drawing for approval in 48 hours \$ 300.00

KEY MEASUREMENTS

- XY010 Seat width (Inside to inside of sideguards)
 (Max - 500mm)
- XY020 Seat length
 (Max - 500mm)
- XY030 Extra Seat Length (Provides additional leg support & hand grip)

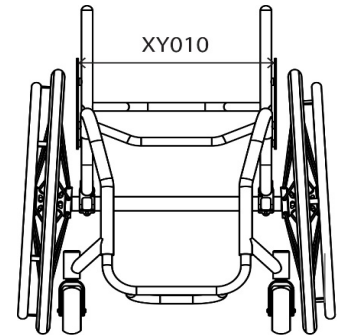

- XY050 Front frame height
 (Max - 550mm) (Min - 380mm)
- XY060 Rear frame height
 (Max - 550mm) (Min - 360mm)
- XY070 Frame length
 (Min = XY020 + XY030 + 140mm)

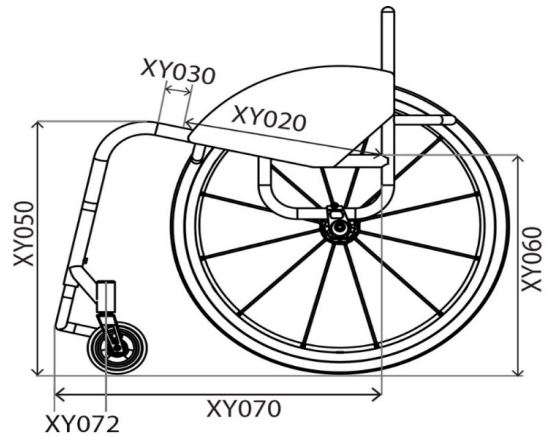

- XY072 Caster position

 Optimize measurements

- XA020 Ergonomic seat \$ 96.00
 (Standard = 120mm)

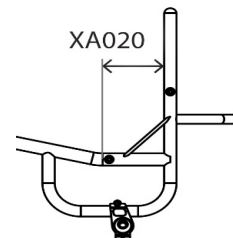

FRONT FRAME AND FOOTREST

Front Frame Options

- XY080 Seat taper design

i Specify width mm

(When combined with XY091, dimension is inbetween the centre of the main bends)

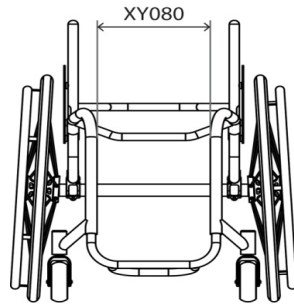

- XY091 Parallel taper design

i Specify width mm

(When combined with XY080, dimensions must be smaller by 20mm)

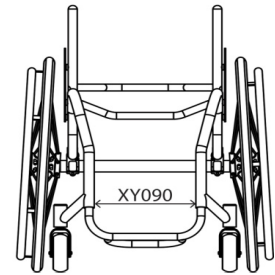

Footrest Design (Choose One)

- XY100 Round design

Caster Size	Max Height	With XB200
3"	140mm	190mm
4"	150mm	200mm
5"	160mm	210mm

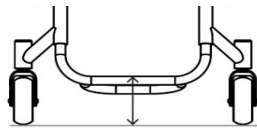

- XY105 Square design

Caster Size	Max Height	With XB200
3"	135mm	185mm
4"	145mm	195mm
5"	155mm	205mm

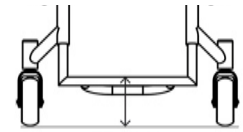

- XB200 High level footrest (Only with XB010, XB080 & XB150)
\$ 160.00

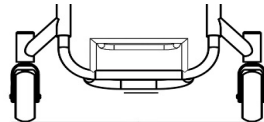

- XB200 High level footrest (Only with XB010, XB080 & XB150)
\$ 160.00

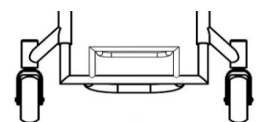

Footrest Individual Measurements

- XY115 Front footrest height

! mm

- XY120 Rear footrest height

i mm (Std = 20 lower than front height)

- XY125 Footrest length

i mm (Std = 100mm) (160mm and over requires heavy duty upgrade XB150)

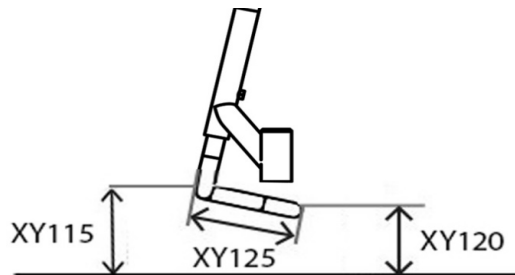

Footrest Style (Choose One)

- XB010 Tubular aluminium footrest (Height adjustable)

- XB030 Flip up plastic footrest \$ 281.00 (Angle/height adjustable, with closed frame only)

- XB070 Angle adjustable aluminium footrest \$ 165.00 (Angle/height adjustable)

- XB150 Heavy duty tubular footrest \$ 143.00 (Height adjustable, for Freewheel use)

- HLTXB080 Tubular footrest welded into frame \$ 96.00 (No height adjustment)

Footrest Cover

- XB050 Carbon fibre cover \$ 197.00 (Not with XB070 & XB030)

- XB170 Aluminium cover \$ 79.00 (Not with XB070 & XB030)

- XB040 Plastic Cover \$ 79.00 (Not with XB070 & XB030)

- XB165 Rubber grip tape \$ 69.00 (3M Safety walk)(not with XB030)

CASTOR WHEELS, FORKS & WHEEL LOCKS

Castor Wheels 75mm (3")

- XC150 Aluminium centre 3"x1.4"
\$ 185.00 *(Silver hub and black urethane tire)*

100mm (4")

- XC060 Soft roll 4"x1.3"
(Black)
- XC110 Aluminium centre 4"x1"
\$ 185.00 *(Silver hub and black urethane tire)*
- XC130 Aluminium centre 4"x1.4"
\$ 185.00 *(choose colour below)*



- | | | | |
|--|--|--|---|
| <input type="checkbox"/> Silver hub & black tire (Std) | <input type="checkbox"/> Black hub & blue tire | <input type="checkbox"/> Purple hub & black tire | <input type="checkbox"/> Silver hub & blue tire |
| <input type="checkbox"/> Black hub & black tire | <input type="checkbox"/> Red hub & black tire | <input type="checkbox"/> Gold hub & black tire | <input type="checkbox"/> Silver hub & red tire |
| <input type="checkbox"/> Black hub & red tire | <input type="checkbox"/> Blue hub & black tire | <input type="checkbox"/> Green hub & black tire | |

125mm (5")

- | | |
|--|---|
| <input type="checkbox"/> XC070 Soft roll 5"x1.3"
<i>(Black)</i> | <input type="checkbox"/> XC120 Froglegs Aluminium centre 5"x1"
\$ 185.00 <i>(Silver hub and black urethane tire)</i> |
| <input type="checkbox"/> XC100 Pneumatic Aluminium centre 5"x1"
\$ 197.00 <i>(Grey)</i> | <input type="checkbox"/> XC140 Froglegs Aluminium centre 5"x1.4"
\$ 185.00 <i>(Silver hub and black urethane tire)</i> |

150mm (6")

- | | |
|--|--|
| <input type="checkbox"/> XC080 Soft roll 6"x1.3" | <input type="checkbox"/> XC145 Frog Legs aluminium centre 6"x1.4"
\$ 247.00 <i>(Silver hub and black urethane tire)</i> |
|--|--|

Castor Forks

- | | |
|---|---|
| <input type="checkbox"/> XC190 Low ride caster fork
<i>(Std when no option selected)</i> | <input type="checkbox"/> XC210 Froglegs suspension caster fork
\$ 504.00 |
|---|---|
- Note: Colour follows accent*
- Black Silver

Castor Pin Width

- XY330 Caster pin width
-
- Optimize measurements

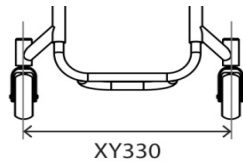

Wheel Lock Options (choose one)

- | | |
|--|---|
| <input type="checkbox"/> XD020 Underseat Scissor | <input type="checkbox"/> XD050 Push to lock |
| <input type="checkbox"/> XD030 Compact scissor
\$ 212.00 | <input type="checkbox"/> XD046 Out Front push to lock |
| <input type="checkbox"/> XD035 Compact scissor with lightweight fixing
\$ 281.00 <i>(Only with fixed centre of gravity)</i> | |
| <input type="checkbox"/> XD045 Out Front Compact scissor
\$ 326.00 | <input type="checkbox"/> XD010 Omit wheel locks |

SIDEGUARDS AND ARMRESTS

Sideguard	Sideguard with Fender
Aluminium Options	Aluminium Options
<input type="checkbox"/> XE030 Screw on aluminium \$ 260.00 <input type="checkbox"/> XE080 Lift out aluminium \$ 424.00 <input type="checkbox"/> XE180 Flip back aluminium \$ 313.00	<input type="checkbox"/> XE040 Screw on aluminium with fender \$ 222.00 <input type="checkbox"/> XE090 Lift out aluminium with fender \$ 461.00 <input type="checkbox"/> XE190 Flip back aluminium with fender \$ 266.00
Carbon Fibre Options	Carbon Fibre Options
<input type="checkbox"/> XE050 Screw on carbon fibre \$ 578.00 <input type="checkbox"/> XE100 Lift out carbon fibre \$ 610.00 <input type="checkbox"/> XE200 Flip back carbon fibre \$ 478.00	<input type="checkbox"/> XE060 Screw on carbon fibre with fender \$ 758.00 <input type="checkbox"/> XE110 Lift out carbon fibre with fender \$ 902.00 <input type="checkbox"/> XE210 Flip back carbon fibre with fender \$ 594.00
ABS Plastic Options	
<input type="checkbox"/> XE070 Screw on ABS plastic \$ 133.00 <input type="checkbox"/> XE120 Lift out ABS plastic \$ 387.00	
Armrest Options	Sideguard Measurements Fender Height
<input type="checkbox"/> XF010 Lift out armrest with plastic sideguard \$ 472.00 <i>(Indicate fixed height)</i> <input type="checkbox"/> XF020 Lift out armrest with Aluminium sideguard \$ 372.00 <i>(Indicate fixed height)</i> <i>Height (Top of seatrail to top of armrest)</i> <input type="checkbox"/> <input style="width: 60px;" type="text"/> mm	<input type="checkbox"/> 10mm above tire <i>(Standard)</i> <input type="checkbox"/> Individual above tire <i>(Min = 10mm)</i> <input type="checkbox"/> <input style="width: 60px;" type="text"/> mm
Sideguard Measurements Optimised measurements	Fender position
<input type="checkbox"/> 25mm above tire <i>(Follow tire)</i> <input type="checkbox"/> Individual above tire <i>(Follow tire)</i> <input type="checkbox"/> <input style="width: 60px;" type="text"/> mm <input type="checkbox"/> Level with tire <i>(Follow tire)</i>	<input type="checkbox"/> Centre of tire <i>(Standard if no option selected)</i> <input type="checkbox"/> Outside of tire
Individual measurements	
<input type="checkbox"/> Sideguard length <input type="checkbox"/> <input style="width: 60px;" type="text"/> mm <input type="checkbox"/> Sideguard height <input type="checkbox"/> <input style="width: 60px;" type="text"/> mm	

BACKREST

Backrest Height - Fixed or Adjustable (Choose One)

XY230 Fixed height backrest

Specify height
 mm

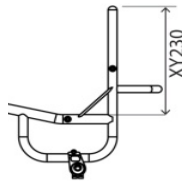

XY245 Adjustable height backrest
 \$ 197.00 (+/25mm)

Specify height
 mm

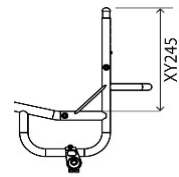

Backrest Design

XG010 Fixed backrest (Non-folding)

HLTXG020 Folding backrest with 2 position snap lock and angle adjust (± 5 Deg)
 \$ 424.00

Ergonomic Options

XY360 Backrest angle

Individual
 -5 -3 0 +3 +5
 Deg
 (Max -10/+20 Deg)

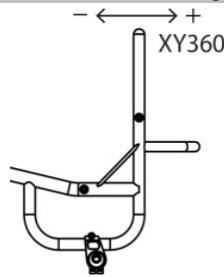

XG100 Ergonomic backrest
 \$ 116.00

Vertical height
 mm

Rearward position
 mm

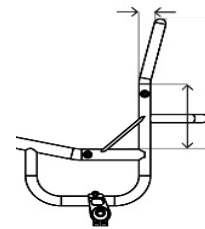

XG110 Inward taper
 \$ 116.00
 (inside of backrest posts)

Specify width or per side
 mm

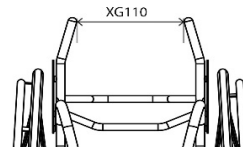

XG120 Outward flare
 \$ 116.00
 (inside of backrest posts)

Specify width or per side
 mm

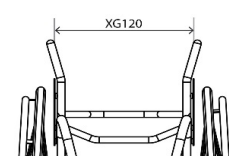

Push handle Options

XG070 Screw in push handles
 \$ 180.00
 (N/A with XY245)

XG080 Flip down push handles
 \$ 250.00
 (N/A with XY245)

XG085 Flip down push handles height adjustable
 \$ 573.00
 (N/A with XY245)

XG090 Stroller push handles height adjustable
 \$ 350.00

Height from floor
 mm Optimize
 (1000mm from floor)

Backrest Options

XG040 Heavy duty backrest upgrade
 \$ 165.00
 (Recommended for hand cycling) (Not with XY245)

XG130 Extra deep brace bar
 \$ 91.00
 (Recommended for JAY backs) (Std - 90mm)

Specify depth
 mm

ILSA Backrest Options

XG140 Integrated lateral support
 \$ 381.00

A - Left
 mm

A - Right
 mm

B - Left
 mm

B - Right
 mm

C - Left
 mm

C - Right
 mm

D - Left
 mm

D - Right
 mm

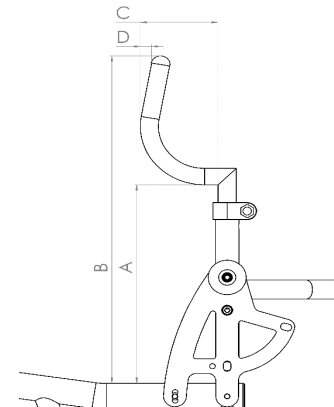

CAMBER BAR

Adjustable Centre of Gravity

XH110 Square back adjustable centre of gravity

(25-150mm)

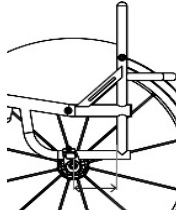

XH120 Round back adjustable centre of gravity

(60-150mm)

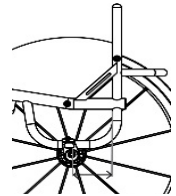

HLTXH090 V-style fixed centre of gravity
\$ 488.00

(25-125mm)

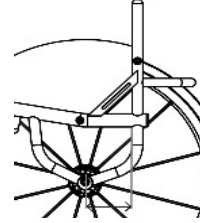

Specify Camber Angle

XY390 Camber angle



Specify Camber Angle

XY390 Camber angle



Camber Bar Options

XH040 Handbike camber bar fixed
\$ 318.00

Camber angle (Handbike camber bar)

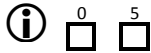

Caster height from floor for handbike fitting

(Standard 30mm if not indicated)



XH030 Frog Legs suspension camber bar
\$ 679.00

Camber Bar Options

XH040 Handbike camber bar fixed
\$ 318.00

Camber angle (Handbike camber bar)

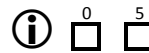

Caster height from floor for handbike fitting

(Standard 30mm if not indicated)

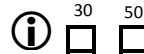

Anti-Tip Options

XJ010 Swingaway anti tip LEFT side (Only with square back frame. Not with XH040)
\$ 133.00

XJ020 Swingaway anti tip RIGHT side (Only with square back frame. Not with XH040)
\$ 133.00

XJ100 Single sport anti tip (centre mounted)
\$ 402.00

REAR WHEELS

Rear Wheel Size

- XY420 24" Wheels
 XY430 25" Wheels
 XY440 26" Wheels

Rear Wheel Gap

- XY460 Rear wheel gap

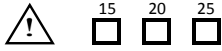

Individual



Wheel Options (Choose one)

- | | |
|--|---|
| <input type="checkbox"/> XK010 Fusion 16 spoke
(Silver Hub, black spokes) | <input type="checkbox"/> XK320 Spinergy XLX 12 spoke
\$ 849.00 |
| <input type="checkbox"/> XK050 Spinergy LX 12 spoke
\$ 796.00 | <input type="checkbox"/> XK060 Spinergy SPOX 18 spoke
\$ 530.00 |
| <input type="checkbox"/> XK150 Spinergy CLX 18 carbon blade spoke
\$1,591.00 (Black Hub only) | <input type="checkbox"/> XK070 Spinergy BLXL 18 blade spoke
\$ 849.00 (Black Hub only) |

Spinergy Colour Options:



- | | | | |
|--|--|--|--|
| <input type="checkbox"/> Black spokes | <input type="checkbox"/> White spokes | <input type="checkbox"/> Yellow spokes | <input type="checkbox"/> XK180 Individual spoke design
\$ 170.00 (Specify colour) |
| <input type="checkbox"/> Red spokes | <input type="checkbox"/> Blue spokes | <input type="checkbox"/> Pink spokes | Inside: _____ |
| <input type="checkbox"/> Purple spokes | <input type="checkbox"/> Orange spokes | <input type="checkbox"/> Green spokes | Outside: _____ |

Spinergy Anodize Options

- | | | | |
|---|---|---|--|
| <input type="checkbox"/> XK190 Black hub
(std option) | <input type="checkbox"/> XK200 Silver hub
\$ 101.00 (n/a with BLXL/CLX) | <input type="checkbox"/> XK201 Red hub/rims
\$ 326.00 (LX, XLX & BLXL only) | <input type="checkbox"/> XK204 Individual:
\$ 429.00 Select colour: _____ |
| <input type="checkbox"/> XK202 Purple hub/rims
\$ 326.00 (LX, XLX & BLXL only) | <input type="checkbox"/> XK203 Blue hub/rims
\$ 326.00 (LX, XLX & BLXL only) | <input type="checkbox"/> XK204 Gold hub/rims
\$ 429.00 (LX, XLX & BLXL only) | |

Supply Without Wheels

- XK040 Supply without Wheels \$ (212.00)
 Wheel Type:
 Tire Type:

Handrim Position / Options

- XY480 Narrow set handrim XY485 Wide set handrim
- XL090 Remove excess mounting tabs
\$ 116.00 (recommended for small wheel gaps)

Handrim Styles

- | | |
|--|---|
| <input type="checkbox"/> XL010 Aluminium hard anodised 6 tab | <input type="checkbox"/> XL040 Titanium 6 tab
\$ 355.00 |
| <input type="checkbox"/> XL020 Tetra grip 6 tab
\$ 318.00 | <input type="checkbox"/> XL050 Stainless steel 6 tab
\$ 197.00 |
| <input type="checkbox"/> XL100 Para grip 6 tab
\$ 318.00 | |

Tire Options

- | | | | |
|--|--|-------------------------------|------------------------------|
| <input type="checkbox"/> XM010 Kenda | <input type="checkbox"/> Grey (std) | <input type="checkbox"/> Blue | <input type="checkbox"/> Red |
| <input type="checkbox"/> XM130 Kenda black
\$ 22.00 | | | |
| <input type="checkbox"/> XM020 Schwalbe Marathon Plus
\$ 79.00 | <input type="checkbox"/> XM060 Schwalbe One
\$ 106.00 (24", 25" only) | | |
| <input type="checkbox"/> XM040 Shox solid airless
(Black) \$ 128.00 | <input type="checkbox"/> XM050 Kenda K885 mountain bike tire
\$ 32.00 (24", 25" only) | | |

Inner Tube Valve Options

- XY500 Schraeder inner tube valve
(Standard if no option selected)
 XY490 Presta inner tube valve

Wheel Accessories

- | | |
|--|--|
| <input type="checkbox"/> XK220 Titanium 130mm quick release axle pins (pair)
\$ 128.00 (N/A with XK010 & XK070) | <input type="checkbox"/> XK300 Offroad wheel set 22" rim with handrim, MTB tire and axle pins (Replaces 24" wheel with XM010)
\$ 743.00 |
| <input type="checkbox"/> XK240 Quad release axle nuts (pair)
\$ 191.00 | <input type="checkbox"/> XK310 Offroad wheel set 24" rim with handrim, MTB tire and axle pins (Replaces 25" wheel with XM010)
\$ 743.00 |

FINISH OPTIONS

Frame & Component Finish

<input type="checkbox"/> XN010	Powder coated frame	<input type="checkbox"/> XN150	Powder coated components <i>(Frame colour if not specified)</i>
Frame	Comp.	Frame	Comp.
Gloss		Matt	
<input type="checkbox"/> <input type="checkbox"/>	Black gloss 103	<input type="checkbox"/> <input type="checkbox"/>	Black matt 105
<input type="checkbox"/> <input type="checkbox"/>	White gloss 100	<input type="checkbox"/> <input type="checkbox"/>	White matt 101
<input type="checkbox"/> <input type="checkbox"/>	Grey gloss 132	<input type="checkbox"/> <input type="checkbox"/>	Grey matt 131
<input type="checkbox"/> <input type="checkbox"/>	Cream gloss 135	<input type="checkbox"/> <input type="checkbox"/>	Light grey matt 133
<input type="checkbox"/> <input type="checkbox"/>	Red gloss 108	<input type="checkbox"/> <input type="checkbox"/>	Navy blue matt 152
<input type="checkbox"/> <input type="checkbox"/>	Yellow gloss 120		
<input type="checkbox"/> <input type="checkbox"/>	Forest green gloss 143		
<input type="checkbox"/> <input type="checkbox"/>	Green gloss 107		
<input type="checkbox"/> <input type="checkbox"/>	Dark blue gloss 151		
<input type="checkbox"/> <input type="checkbox"/>	Royal blue gloss 154		
<input type="checkbox"/> <input type="checkbox"/>	Blue gloss 174		
<input type="checkbox"/> <input type="checkbox"/>	Duckegg blue gloss 141		
<input type="checkbox"/> <input type="checkbox"/>	Pink gloss 188		
<input type="checkbox"/> <input type="checkbox"/>	Orange gloss 180		
<input type="checkbox"/> <input type="checkbox"/>	Purple gloss 157		
<input type="checkbox"/> HLTXN030	Bead blast frame \$ 450.00 <i>(All parts black unless XN160 chosen)</i>	<input type="checkbox"/> XN200	Individual paint colour (State Colour/RAL code) \$ 450.00
<input type="checkbox"/> HLTXN050	Polished frame \$ 530.00 <i>(All parts black unless XN160 chosen)</i>	<input type="checkbox"/> XN165	Bead blast components \$ 101.00
		<input type="checkbox"/> XN170	Polished components \$ 170.00

Accent Colour

Note: Accent colour includes, forks, castor caps and axle clamps.

<input type="checkbox"/>	Black accent	<input type="checkbox"/>	Silver accent	<input type="checkbox"/> XN250	Individual Accent Colour \$ 250.00
<input type="checkbox"/>	Red accent	<input type="checkbox"/>	Blue accent		
<input type="checkbox"/>	Purple accent				

UPHOLSTERY

Seat Upholstery

<input type="checkbox"/> XP040	Seat sling adjustable tension with straps	<input type="checkbox"/> XR050	Carbon fibre seat plate \$ 382.00
--------------------------------	---	--------------------------------	--------------------------------------

Backrest Upholstery

<input type="checkbox"/> XP050	Airtech backrest strap adjustable	<input type="checkbox"/> XP070	Backrest upgrade to leather corners (Black) \$ 96.00
--------------------------------	-----------------------------------	--------------------------------	---

Backrest Stitching Options

<input type="checkbox"/> Silver	<input type="checkbox"/> Black	<input type="checkbox"/> Blue	<input type="checkbox"/> Individual:
<input type="checkbox"/> Red	<input type="checkbox"/> Light blue	<input type="checkbox"/> Purple	_____

Backrest RGK Logo Colour

<input type="checkbox"/> White (Std)	<input type="checkbox"/> Green	<input type="checkbox"/> Blue	<input type="checkbox"/> Individual:
<input type="checkbox"/> Red	<input type="checkbox"/> Light blue	<input type="checkbox"/> Purple	_____

Backrest Accessories

<input type="checkbox"/> XP110	Backrest with zip pocket \$ 101.00	<input type="checkbox"/> XP170	Individual backrest embroidery \$ 160.00 <i>(Please provide jpeg file and positioning)</i>
--------------------------------	---------------------------------------	--------------------------------	--

CUSHION

Cushion foam options

- XP080 Cushion foam
\$ 96.00 (select density and size below)
- Soft (CMS040) Medium (CMS050) Hard (9lb recon)
- 50mm 75mm 100mm

Cushion cover options

- XP081 Nylon cushion cover
(Black)
- XP090 Air Lite cushion cover
\$ 79.00 (Black)
- XP100 Leather cushion cover
\$ 202.00 (Black)

Jay Products

- JAY Cushion
(Price dependant on size / option) Jay Order form attached
- JAY Backrest
(Price dependant on size / option) Jay Order form attached
- JAY Whitmyer Headrest
(Price dependant on size / option) Jay Order form attached

Notes:

FRAME OPTIONS

- XR060 Welded calf strap mounting loops
\$ 122.00 (To locate calf strap on front frame)
- Specify height from floor
-
- Optimise measurements

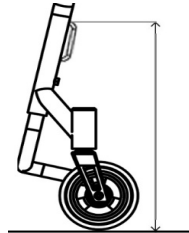

ACCESSORIES

- XR080 Frontwheel assembly
\$ 838.00 (Only with Tubular style footrest)
- XP120 Frame protectors Neoprene zip fasten with TIGA logo
\$ 67.00 (Black)
- XP420 Frame protectors Nylon velcro fasten
\$ 64.00 (Black)
- XR010 Seat pouch velcro attach
\$ 47.00 (Black)
- XR200 Rucksack with RGK logo
\$ 120.00 (Black)
- XR020 Underseat large storage bag
\$ 101.00 (Black)
- XA020 Tool kit
- XS060 Calf strap

