



Serial Number: _____

Manufacturing Date: _____/20_____



49 Bespoke Inc. 51 Caldari Road, Units 6-7B
Concord, ON
L4K 4G3, Canada

Telephone: +1.866.827.4548
Fax: +1.877.731.7745
49@49Bespoke.com www.49Bespoke.com



Distributor Name: _____

Contact Name: _____

Address: _____

Postcode: _____

Country: _____

Telephone: _____

Email: _____

Dealers Name: _____

Client's Name: _____

Client's Weight: _____

Client's Height: _____

Client's Disability: _____

Purchase Order No: _____

Delivery Address: _____

Postcode: _____

Contact Name: _____

Telephone: _____

Email: _____

Notes/Comments:

Do Not Use for Specification Information

FOR RGK OFFICE USE ONLY

Distributor: _____

A/C No: _____

Net Value: \$ _____

Freight: \$ _____

Invoice Value: \$ _____

Payment Received: \$ _____

	Who	Date
OK to Quote:		
OK to Confirm:		
Document No:	DOC	

●	Base product	⚠	Mandatory information	ⓘ	Information required for option
■	Standard configuration	□	Option with no extra cost	○	Option with extra cost

●	SBAXZ010	TIGA Sub4 A7020	
	\$	6,650.00	
■	XA070	Frame open design	

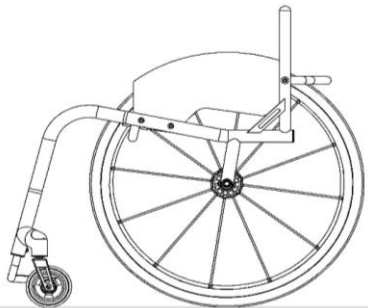

Max User Weight 110kg

○	XW010	NC
---	-------	----

KEY FRAME MEASUREMENTS

- XY010 Seat width *(Inside of sideguards)*

⚠ mm *(Max - 440mm)*
(Min - 250mm)
- XY020 Seat length

⚠ mm *(Max - 440mm)*
(Min - 250mm)
- XY030 Seat frame additional length *(Provides additional leg support & hand grip)*

ⓘ mm *(Max - 440mm total seat)*
- XY050 Front frame height

⚠ mm *(Max - 520mm)*
(Min - 380mm)
- XY060 Rear frame height

⚠ mm *(Max - 500mm)*
(Min - 360mm)
- XY070 Frame length

⚠ mm *(Min = XY020 + XY030 + 110mm)*
(Max - 625mm)
- XA020 Frame ergonomic seat

\$ 93.00

ⓘ Specify length mm *(Standard = 120mm)*

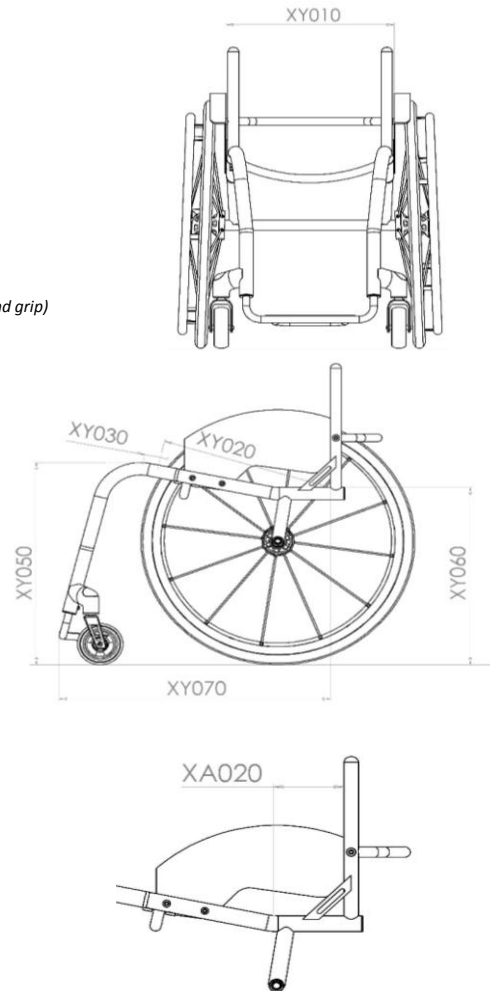

FRONT FRAME AND FOOTREST

Front Frame Options

XY080 Front seat taper design

Specify width
 mm

(Optional, to provide additional leg support / positioning)

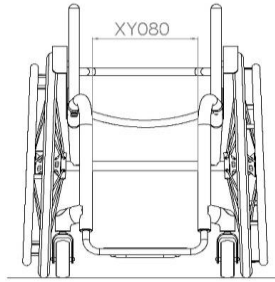

Footrest width

Specify width
 mm

(When combined with XY080, dimensions must be smaller)

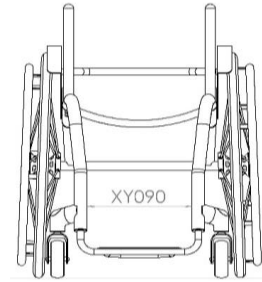

Footrest Design & Measurements (Choose One)

XY100 Footrest round design (Minimum 60mm)

Please indicate front footrest height:

60 80 100 120

Individual mm

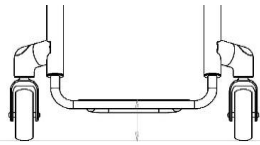

Castor Wheel Size	Max Height Achievable
4"	110mm

XY105 Footrest square design (Square design allows higher position) (Minimum 60mm)

Please indicate front footrest height:

60 80 100 120

Individual mm

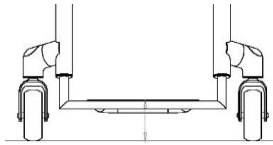

Castor Wheel Size	Max Height Achievable
4"	130mm

Footrest Individual Measurements

Rear footrest height

mm

Optimise measurements (Std = Footrest height - 20mm)

Footrest length

mm

Maximum length 140mm

Optimise measurements (Std = 100mm)

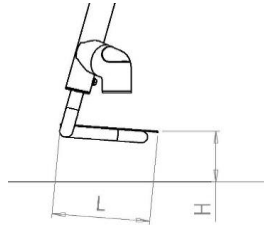

Footrest Style

XB010 Footrest height adjustable lightweight tubular aluminium

Footrest Cover

XB045 Footrest cover lightweight carbon fibre

CASTOR WHEELS, FORKS & WHEEL LOCKS

Castor Wheels

- XC135 Castor wheel 4x1.25" aluminium centre with urethane tyre frog legs
Choose colour below:



- | | |
|--|---|
| <input type="checkbox"/> Silver hub & black tyre (Std) | <input type="checkbox"/> Green hub & black tyre |
| <input type="checkbox"/> Black hub & black tyre | <input type="checkbox"/> Red hub & black tyre |
| <input type="checkbox"/> Purple hub & black tyre | <input type="checkbox"/> Blue hub & black tyre |

Castor Forks

- XC190 Castor fork low ride daily use



- Black
- Silver

Castor Pin Width

- XY330 Castor pin width
- Optimise measurements
(Minimum width for clear castor rotation and maximum wheelbase length)

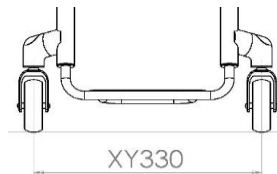

Wheel Lock Options

- SBAXD036 Wheel locks compact scissor with lightweight fixing
- XD010 Wheel locks omit

SIDEGUARDS

Sideguard

Carbon Fibre Options

- XE055 Sideguards screw on lightweight carbon fibre

Sideguard Measurements
Optimised measurements

- Sideguard individual above tyre
(Follow tyre) max 25mm

mm

- Sideguard level with tyre *(Follow tyre)*

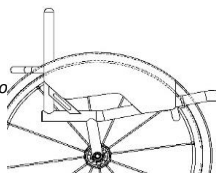

Sideguard with Fender
Carbon Fibre Options

- XE065 Sideguards screw on lightweight carbon fibre with fender

Sideguard Measurements
Optimised measurements

Fender sideguard height above tyre *(Min = 10mm)*



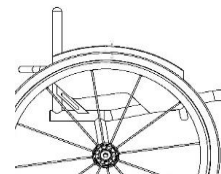

mm

- Optimise
10mm above tyre *(Std if not indicated)*

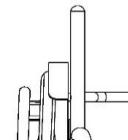

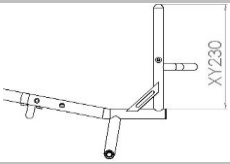
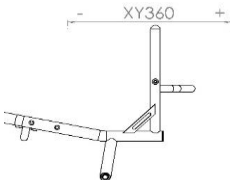
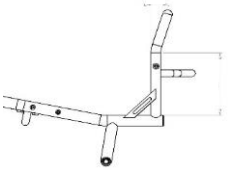
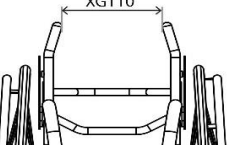
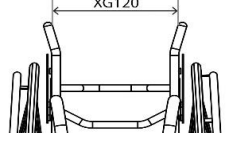
- Fender sideguard to centre of tyre

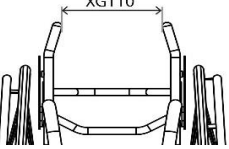

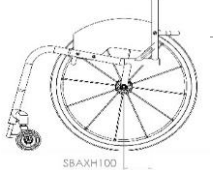
BACKREST	
Backrest Height - Fixed	Backrest Design - Fixed
<input checked="" type="checkbox"/> Backrest height fixed Specify height <input style="width: 100px; border: 1px solid black;" type="text"/> mm 	<input checked="" type="checkbox"/> XG010 Backrest fixed (Non-folding)
Ergonomics - Rearward Positioning (Choose One)	
<input checked="" type="checkbox"/> XY360 Backrest angle -5 -3 0 +3 +5 Individual <input style="width: 100px; border: 1px solid black;" type="text"/> Deg (Max -10/+20 Deg) 	<input type="checkbox"/> XG100 Backrest ergonomic \$ 113.00 Vertical height (Min 250mm) <input style="width: 100px; border: 1px solid black;" type="text"/> mm Rearward position <input style="width: 100px; border: 1px solid black;" type="text"/> mm 
Ergonomics - Lateral Positioning (Choose One)	
<input type="checkbox"/> XG110 Backrest inward taper \$ 113.00 (Above sideguards) Width <input style="width: 100px; border: 1px solid black;" type="text"/> mm 	<input type="checkbox"/> XG120 Backrest outward flare \$ 113.00 (Above sideguards) Width <input style="width: 100px; border: 1px solid black;" type="text"/> mm 
CAMBER BAR	
Specify Camber Angle	Fixed Centre of Gravity
<input checked="" type="checkbox"/> XY390 Camber angle  1 2 3 	<input checked="" type="checkbox"/> SBAXH100 Camber bar fixed position welded into frame single post (25-125mm)  <input style="width: 100px; border: 1px solid black;" type="text"/> mm 
FRAME FINISH OPTIONS	
Frame and Footrest	
<input type="checkbox"/> SBAXN030 Finish frame brushed	<input type="checkbox"/> SBAXN050 Finish frame polished
Accent Colour (Choose One)	
<input type="checkbox"/> Finish accent colour black <input type="checkbox"/> Finish accent colour red <input type="checkbox"/> Finish accent colour purple	<input type="checkbox"/> Finish accent colour silver <input type="checkbox"/> Finish accent colour blue
UPHOLSTERY	
Seat Upholstery	
<input checked="" type="checkbox"/> XP045 Upholstery seat sling Sub4 adjustable tension	
Backrest Upholstery	
<input checked="" type="checkbox"/> XP035 Upholstery backrest Sub4 adjustable tension	
Backrest Upholstery Stitching Options	
<input type="checkbox"/> Silver (Standard if not indicated) <input type="checkbox"/> Red	<input type="checkbox"/> Black <input type="checkbox"/> Light blue
<input type="checkbox"/> Blue <input type="checkbox"/> Purple	
Other Upholstery	
<input checked="" type="checkbox"/> XS065 Accessory lightweight Calf Strap	

REAR WHEELS (* non certified weight options)													
Wheel Size													
<input type="checkbox"/> XY420 Wheel size 24"	<input type="checkbox"/> XY430 Wheel size 25"												
Wheel Gap													
<input checked="" type="checkbox"/> XY460 Rear wheel gap 15 <input type="checkbox"/> 20 <input type="checkbox"/> 25 <input type="checkbox"/>													
Wheel Options													
<input checked="" type="checkbox"/> XK225 Wheel titanium quick release axle pin (pair)	<input checked="" type="checkbox"/> XK075 Wheel Spinerger BLXL 18 blade spoke daily, rivnut handrim mounting (select colour below - Note: Black hub only)												
<div style="display: flex; justify-content: space-between;"> <div style="width: 45%;"> <p>i Spinerger Colour Options</p> <table style="width: 100%; border: none;"> <tr> <td><input type="checkbox"/> Black spoke / Black hub</td> <td><input type="checkbox"/> White spoke / Black Hub</td> </tr> <tr> <td><input type="checkbox"/> Red spoke / Black hub</td> <td><input type="checkbox"/> Blue spoke / Black hub</td> </tr> <tr> <td><input type="checkbox"/> Yellow spoke / Black hub</td> <td><input type="checkbox"/> Green spoke / Black hub</td> </tr> <tr> <td><input type="checkbox"/> Pink spoke / Black hub</td> <td><input type="checkbox"/> Orange spoke / black hub</td> </tr> </table> </div> <div style="width: 45%;"> <p><input type="radio"/> XK180 Spinerger spoke colour custom \$ 165.00 (Specify below)</p> <table style="width: 100%; border: none;"> <tr> <td style="width: 50%;">i Colour inside</td> <td style="width: 50%;"><input style="width: 100%;" type="text"/></td> </tr> <tr> <td>Colour outside</td> <td><input style="width: 100%;" type="text"/></td> </tr> </table> <p><i>Note: Supply picture for custom designs</i></p> </div> </div>		<input type="checkbox"/> Black spoke / Black hub	<input type="checkbox"/> White spoke / Black Hub	<input type="checkbox"/> Red spoke / Black hub	<input type="checkbox"/> Blue spoke / Black hub	<input type="checkbox"/> Yellow spoke / Black hub	<input type="checkbox"/> Green spoke / Black hub	<input type="checkbox"/> Pink spoke / Black hub	<input type="checkbox"/> Orange spoke / black hub	i Colour inside	<input style="width: 100%;" type="text"/>	Colour outside	<input style="width: 100%;" type="text"/>
<input type="checkbox"/> Black spoke / Black hub	<input type="checkbox"/> White spoke / Black Hub												
<input type="checkbox"/> Red spoke / Black hub	<input type="checkbox"/> Blue spoke / Black hub												
<input type="checkbox"/> Yellow spoke / Black hub	<input type="checkbox"/> Green spoke / Black hub												
<input type="checkbox"/> Pink spoke / Black hub	<input type="checkbox"/> Orange spoke / black hub												
i Colour inside	<input style="width: 100%;" type="text"/>												
Colour outside	<input style="width: 100%;" type="text"/>												
<input type="radio"/> XK040 Wheel omit / supply without \$ (206.00) (Specify wheel type / size / tyre)	i <input style="width: 100%;" type="text"/>												
Handrim Position													
<input type="checkbox"/> Handrim set narrow (Standard if no option selected)	<input type="checkbox"/> Handrim set wide												
Handrim Options													
<input type="checkbox"/> XL010 Handrim aluminium hard anodised 6 tab (Lightest Option) (Standard if no option selected) <input type="radio"/> XL030 Handrim surge LT 6 tab \$ 484.00 <input type="radio"/> XL020 Handrim tetra grip 6 tab \$ 309.00 <input type="radio"/> XL100 Handrim para grip 6 tab \$ 309.00	<input type="radio"/> XL040 Handrim titanium 6 tab \$ 345.00 <input type="radio"/> XL050 Handrim stainless steel 6 tab \$ 191.00 <input type="radio"/> XL090 Handrim remove excess mounting tab \$ 113.00 (Recommended when XY460 is 20mm or less) (Narrow set only)												
Tyre Options													
<input type="radio"/> XM060 Tyre Schwalbe One (Lightest option) \$ 103.00 <input type="checkbox"/> XM010 Kenda Tyre High Pressure i <input type="checkbox"/> Grey (Standard if no option selected) <input type="checkbox"/> Blue <input type="checkbox"/> Red <input type="radio"/> XM130 Kenda black \$ 21.00 <input type="radio"/> XM020 Tyre Schwalbe Marathon Plus \$ 77.00 <input type="radio"/> XM040 Tyre Shox solid airless black only \$ 124.00 (24", 25" only)	<input type="radio"/> XM050 Tyre Kenda K885 mountain bike tyre \$ 31.00 (24", 25" only)												
Inner Tube Valve Options													
<input type="checkbox"/> XY500 Schraeder inner tube valve (Standard if no option selected)	<input type="checkbox"/> XY490 Presta inner tube valve												

* Indicates items that are not part of the certified weight of the TIGA Sub4

OTHER (** non certified weight options)					
Footrest					
<input type="radio"/>	XB200 Footrest with high level riser system \$ 155.00	Please indicate front footrest height: <input style="width: 100px; height: 20px; border: 1px solid black;" type="text"/> mm			
Castor wheels 3 and 5"					
<input type="radio"/>	XC150 Castor wheel 3x1.4" aluminium centre frog legs \$ 180.00 <i>(Silver hub and black urethane tyre)</i>				
<input type="checkbox"/>	XC070 Castor wheel 5x1.3" soft roll black				
<input type="radio"/>	XC100 Castor wheel 5" pneumatic aluminium centre \$ 191.00				
<input type="radio"/>	XC120 Castor wheel 5x1" aluminium centre frog legs \$ 180.00 <i>(Silver hub & black urethane tyre)</i>				
<input type="radio"/>	XC140 Castor wheel 5x1.4" aluminium centre frog legs \$ 180.00 <i>(Silver hub & black urethane tyre)</i>				
Wheel Lock Options					
<input type="checkbox"/>	XD020 Wheel locks underseat scissor	<input type="checkbox"/> XD050 Wheel locks push to lock			
Sideguards					
<input type="radio"/>	XE030 Sideguards screw on aluminium, indicate size on page 4 \$ 252.00				
Backrest Options					
<input type="radio"/>	SBAXG020 Backrest folding with 2 position snap lock and angle adjust \$ 295.00				
Push handle Options					
<input type="radio"/>	XG070 Backrest with screw in push handles <i>(N/A with XY245)</i> \$ 175.00	<input type="radio"/> XG080 Backrest with flip down push handles \$ 340.00			
Anti-Tip Options					
<input type="radio"/>	XJ100 Anti tip single sport \$ 390.00				
Seat Upholstery					
<input type="checkbox"/>	XP040 Upholstery seat sling adjustable tension with straps	<input type="radio"/> XR050 Accessory carbon fibre seat plate in lieu of seat upholstery \$ 371.00			
Backrest Upholstery					
<input type="checkbox"/>	XP050 Upholstery backrest Airtech adjustable tension with straps				
Backrest Upholstery Leather Options (only with XP050)					
<input type="radio"/>	XP070 Upholstery upgrade to leather corners on side wings - <i>(N/A with XG080)</i> \$ 93.00	<table style="width: 100%; border: none;"> <tr> <td style="text-align: center; width: 33%;"><input type="checkbox"/> Leather colour black <i>(Standard if not Indicated)</i></td> <td style="text-align: center; width: 33%;"><input type="checkbox"/> Leather colour red</td> <td style="text-align: center; width: 33%;"><input type="checkbox"/> Leather colour grey</td> </tr> </table>	<input type="checkbox"/> Leather colour black <i>(Standard if not Indicated)</i>	<input type="checkbox"/> Leather colour red	<input type="checkbox"/> Leather colour grey
<input type="checkbox"/> Leather colour black <i>(Standard if not Indicated)</i>	<input type="checkbox"/> Leather colour red	<input type="checkbox"/> Leather colour grey			
Backrest Upholstery Stitching Options (only with XP050)					
<input type="checkbox"/>	Silver <i>(Standard if not indicated)</i>	<input type="checkbox"/> Black			
<input type="checkbox"/>	Red	<input type="checkbox"/> Light blue			
<input type="checkbox"/>	Blue	<input type="checkbox"/> Purple			
Backrest Upholstery Logo Options (only with XP050)					
<input type="checkbox"/>	Silver <i>(Standard if not indicated)</i>	<input type="checkbox"/> Black			
<input type="checkbox"/>	Red	<input type="checkbox"/> Light blue			
<input type="checkbox"/>	Blue	<input type="checkbox"/> Purple			
Backrest Accessories (only with XP050)					
<input type="radio"/>	XP110 Upholstery backrest with zip fasten pocket \$ 98.00	<input type="radio"/> XP170 Upholstery with individual embroidery \$ 155.00 <i>(Please provide .jpeg file and positioning)</i>			
** indicates options that, when chosen, will not enable RGK to guarantee a Sub4kg product weight					

