



Distributor Name: _____

Contact Name: _____

Address: _____

Postcode: _____

Country: _____

Telephone: _____

Email: _____

Dealers Name: _____

Client's Name: _____

Client's Weight: _____

Client's Height: _____

Client's Disability: _____

Purchase Order No: _____

Delivery Address: _____

Postcode: _____

Contact Name: _____

Telephone: _____

Email: _____

Notes/Comments:

Do Not Use for Specification Information

FOR RGK OFFICE USE ONLY

Distributor: _____

A/C No: _____

Net Value: _____

Freight: \$ _____

Invoice Value: \$ _____

Payment Received: \$ _____

	Who	Date
OK to Quote:		
OK to Confm:		
Document No:	DOC	

<input checked="" type="checkbox"/>	Base Product	<input type="checkbox"/>	Mandatory Informaton	<input type="checkbox"/>	Informaton Required for Opton
<input checked="" type="checkbox"/>	Standard Configuraton	<input type="checkbox"/>	Opton with No extra cost	<input type="checkbox"/>	Opton with Extra cost
<input checked="" type="checkbox"/>	FXAXZ010 TIGA FX A7020 \$ 6,314.00				
<input checked="" type="checkbox"/>	XA070 Frame open design				
Max User Weight 125kg					
<input type="checkbox"/>	XW010 NC				

KEY FRAME MEASUREMENTS

- XY010 Seat width *(Inside of sideguards)*
 (Max - 460mm)
 (Min - 250mm)
- XY020 Seat length
 (Max - 460mm)
 (Min - 250mm)
- XY030 Seat frame additional length *(Provides additional leg support & hand grip)*
- XY050 Front frame height
 (Max - 550mm)
 (Min - 480mm)
- XY060 Rear frame height
 (Max - 550mm)
 (Min - 360mm)
- XY070 Frame length
 (Min XY020 + XY030 + 110mm)
- XA020 Frame ergonomic seat
 \$ 96.00
 Specify length
 (Standard = 120mm)

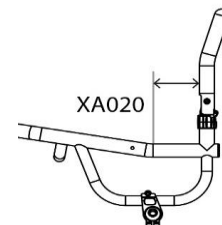
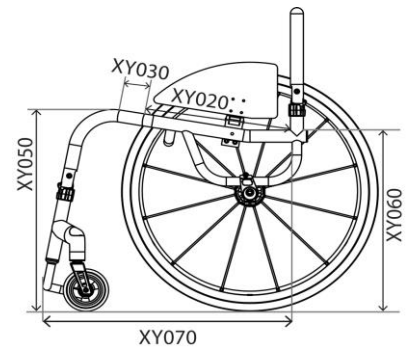
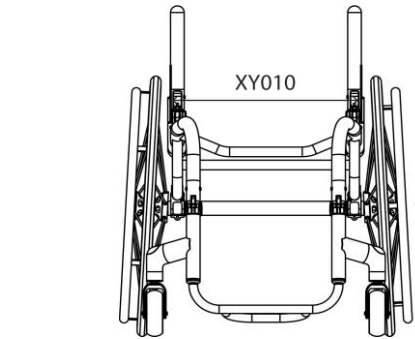

FRONT FRAME AND FOOTREST

Front Frame Options

XY080 Front seat taper design

Specify width

_____ mm

Optimise measurements (XY010 - 100mm)

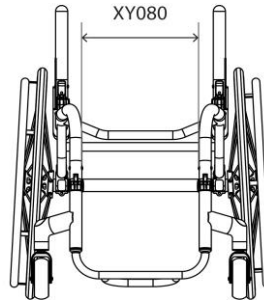

Footrest Design & Measurements (Choose One)

XY100 Footrest round design (Minimum 60mm)

Please indicate front footrest height:

60 80 100 120

Individual _____ mm

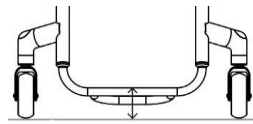

Castor Wheel Size	Max Height Achievable	With XB200
3"	115mm	165mm
4"	125mm	175mm
5"	135mm	185mm

XB200 Footrest with high level riser system (Only with \$ 160.00 FXAXB110)

XY105 Footrest square design (Square design allows higher position) (Minimum 60mm)

Please indicate front footrest height:

60 80 100 120

Individual _____ mm

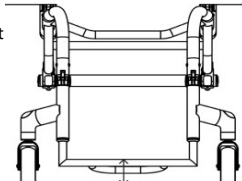

Castor Wheel Size	Max Height Achievable	With XB200
3"	135mm	185mm
4"	145mm	195mm
5"	155mm	205mm

XB200 Footrest with high level riser system (Only with \$ 160.00 FXAXB110)

Footrest Individual Measurements

Rear footrest height

_____ mm

Optimise measurements (Std = Footrest height - 20mm)

Footrest length

_____ mm

Optimise measurements (Std = 100mm)

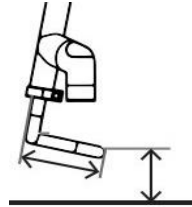

Footrest Style and Cover (Choose One)

FXAXB110 Footrest fixed position welded into frame with carbon plate (Supplied with spacer kit to give 20mm upward adjustment)

XB160 Footrest grip tape fitted to any footrest cover \$ 42.00

FXAXB120 Footrest clamp-on height and angle adjustable aluminium plate

CASTOR WHEELS, FORKS & WHEEL LOCKS

Castor Wheels

3"

- XC150 Castor wheel 3x1.4" aluminium centre frog legs (Silver hub and black urethane tyre)
\$ 185.00

4"

- XC060 Castor wheel 4x1.3" sof roll black
- XC110 Castor wheel 4x1" aluminium centre frog legs (Silver hub & black urethane tyre)
\$ 185.00
- XC130 Castor wheel 4x1.4" aluminium centre with urethane tyre frog legs
\$ 185.00 Choose colour below (XC130 Only) :

- | | | | |
|--|--|--|---|
| <input type="checkbox"/> Silver hub & black tyre (Std) | <input type="checkbox"/> Black hub & blue tyre | <input type="checkbox"/> Purple hub & black tyre | <input type="checkbox"/> Silver hub & blue tyre |
| <input type="checkbox"/> Black hub & black tyre | <input type="checkbox"/> Red hub & black tyre | <input type="checkbox"/> Gold hub & black tyre | <input type="checkbox"/> Silver hub & red tyre |
| <input type="checkbox"/> Black hub & red tyre | <input type="checkbox"/> Blue hub & black tyre | <input type="checkbox"/> Green hub & black tyre | |

5"

- XC070 Castor wheel 5x1.3" sof roll black
- XC100 Castor wheel 5" pneumatic aluminium centre
\$ 197.00
- XC120 Castor wheel 5x1" aluminium centre frog legs (Silver hub & black urethane tyre)
\$ 185.00
- XC140 Castor wheel 5x1.4" aluminium centre frog legs (Silver hub & black urethane tyre)
\$ 185.00

Choose one castor opt on only

Castor Forks

- | | | |
|--|---|---|
| <input type="checkbox"/> XC190 Castor fork low ride daily use (Standard when no option selected) | <input type="radio"/> XC210 Castor fork suspension frog legs
\$ 504.00 | <input type="radio"/> XC220 Castor fork single sided uni tne frog legs
\$ 197.00 |
| <input type="checkbox"/> Black <input type="checkbox"/> Silver | <input type="checkbox"/> Black <input type="checkbox"/> Silver | <input type="checkbox"/> Black <input type="checkbox"/> Silver |

Castor Pin Width

- XY330 Castor pin width (XY010 plus 70mm)

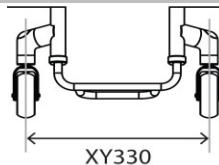

Wheel Lock Options

Scissor

- XD020 Wheel locks underseat scissor
- XD040 Wheel locks scissor levers drilled
\$ 59.00
- XD030 Wheel locks compact scissor
\$ 212.00
- XD035 Wheel locks compact scissor with lightweight fixing
\$ 281.00 (Only with fixed centre of gravity)

Other

- XD050 Wheel locks push to lock
- XD010 Wheel locks omit

SIDEGUARDS AND ARMRESTS

Sideguard		Sideguard with Fender	
Aluminium Options		Aluminium Options	
<input type="radio"/>	XE080 Sideguards lif out aluminium \$ 424.00	<input type="radio"/>	XE090 Sideguards lif out aluminium with fender \$ 461.00
<input type="radio"/>	FXAXE130 Sideguards fold fat aluminium \$ 391.00	<input type="radio"/>	FXAXE140 Sideguards fold fat aluminium with fender \$ 435.00
Carbon Fibre Options		Carbon Fibre Options	
<input type="radio"/>	XE100 Sideguards lif out carbon fibre \$ 610.00	<input type="radio"/>	XE110 Sideguards lif out carbon fibre with fender \$ 902.00
<input type="radio"/>	FXAXE150 Sideguards fold fat carbon fibre \$ 652.00	<input type="radio"/>	FXAXE160 Sideguards fold fat carbon fibre with fender \$ 796.00
ABS Plastic Options		Sideguard Measurements	
<input type="radio"/>	XE120 Sideguards lif out ABS plastic \$ 387.00	Optimised measurements	
<input type="radio"/>	FXAXE170 Sideguards fold fat ABS plastic \$ 391.00	<p>Fender sideguard height above tyre (Min = 10mm)</p> <p><input type="text"/> mm</p> <p><input type="checkbox"/> Optimise (10mm above tyre)</p>	
Armrest Options		Individual measurements	
<input type="radio"/>	XF010 Armrest fixed height, lif out with plastic sideguard \$ 472.00 (Indicate height)	<input type="checkbox"/>	Fender sideguard to centre of tyre (Standard if no option selected)
<input type="radio"/>	XF020 Armrest fixed height, lif out with aluminium sideguard \$ 372.00 (Indicate height)	<input type="checkbox"/>	Fender sideguard to outside of tyre
<p><input type="checkbox"/> Height (Top of seatrail to top of armrest)</p> <p><input type="text"/> mm</p>			
Sideguard Measurements		Choose optimised or individual measurements	
Optimised measurements		Choose optimised or individual measurements	
<input type="checkbox"/>	Sideguard 25mm above tyre (Follow tyre - Std if not indicated)		
<input type="checkbox"/>	Sideguard individual above tyre (Follow tyre)		
<input type="checkbox"/>	Sideguard level with tyre (Follow tyre)		
Individual measurements		Choose optimised or individual measurements	
Sideguard length			
<input type="text"/>	mm		
Sideguard height			
<input type="text"/>	mm		

BACKREST

Backrest Height - Fixed or Adjustable (Choose One)

Backrest height fixed
(Maximum 400mm)
Specify height

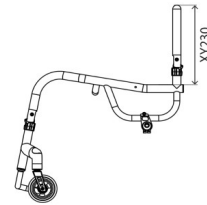
 mm

XY245 Backrest height adjustable
\$ 197.00
(Maximum 400mm)
(Upward range 50mm)

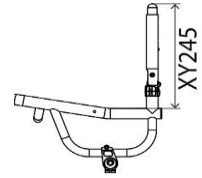

Indicate lowest height

 mm

Backrest Design - Fixed or Folding (Choose One)



FXAXG060 Backrest folding with Q Lock

Ergonomics - Rearward Positioning (Choose One)



XY360 Backrest angle

-5 -3 0 +3 +5

Individual

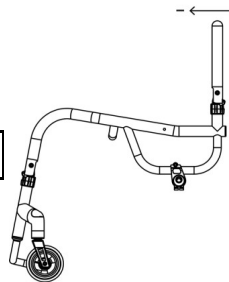
 Deg
(Max -7/+7 Deg)

XG100 Backrest ergonomic
\$ 116.00
Vertical height (Min
250mm)

 mm

Rearward position

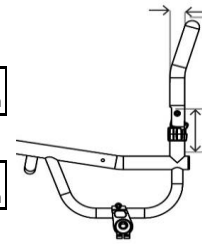
 mm

Ergonomics - Lateral Positioning (Choose One)

XG110 Backrest inward taper
\$ 116.00
(Above sideguards)

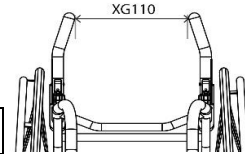

Width

 mm

XG120 Backrest outward flare
\$ 116.00
(Above sideguards)

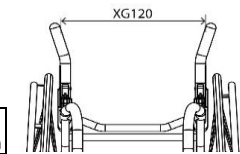

Width

 mm



Push handle Options

XG070 Backrest with screw in push handles (N/A
\$ 180.00 with XY245)

XG080 Backrest with flip down push handles (N/A
\$ 350.00 with XY245)

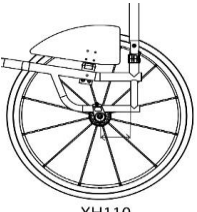
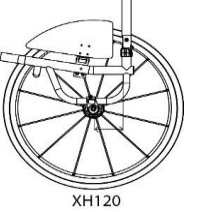
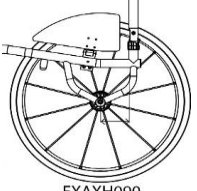
XG085 Backrest with flip down push handles height
\$ 573.00 adjustable (N/A with XY245)

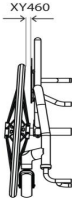
CAMBER BAR			
Centre of gravity - Choose one	Adjustable Centre of Gravity	<input type="checkbox"/> XH110 Camber bar adjustable position square back frame (25-150mm) (Max seat width 500mm) <input type="checkbox"/> XH120 Centre of gravity adjustable round back frame (60-150mm)	 XH110  XH120
	Fixed Centre of Gravity	<input type="radio"/> FXAXH090 Camber bar fixed position integrated into frame V design (25-125mm) <input type="checkbox"/> _____ mm	 FXAXH090
Specify Camber Angle		Specify Camber Angle	
<input checked="" type="checkbox"/> XY390 Camber angle <input type="checkbox"/> 0 <input type="checkbox"/> 1 <input type="checkbox"/> 2 <input type="checkbox"/> 3 <input type="checkbox"/> 5		<input checked="" type="checkbox"/> XY390 Camber angle <input type="checkbox"/> 0 <input type="checkbox"/> 1 <input type="checkbox"/> 2 <input type="checkbox"/> 3 <input type="checkbox"/> 5	
Camber Bar Options		Camber Bar Options	
<input type="radio"/> XH030 Suspension camber bar frog legs \$ 679.00 <input type="radio"/> XH040 Handbike camber bar fixed welded \$ 318.00 Camber angle (Handbike camber bar) <input type="checkbox"/> 0 <input type="checkbox"/> 5 Castor height from foot for handbike fitting (Standard 30mm if not indicated) <input type="checkbox"/> 30 <input type="checkbox"/> 50		<input type="radio"/> XH040 Handbike camber bar fixed welded \$ 318.00 Camber angle (Handbike camber bar) <input type="checkbox"/> 0 <input type="checkbox"/> 5 Castor height from foot for handbike fitting (Standard 30mm if not indicated) <input type="checkbox"/> 30 <input type="checkbox"/> 50	
Ant-Tip Options			
<input type="radio"/> XJ010 Ant tip swingaway left side (Only with square back frame. Not with XH040) \$ 133.00		<input type="radio"/> XJ020 Ant tip swingaway right side (Only with square back frame. Not with XH040) \$ 133.00	

REAR WHEELS											
Wheel Size											
<input type="checkbox"/> XY420	Wheel size 24"	<input type="checkbox"/> XY430	Wheel size 25"								
		<input type="checkbox"/> XY440	Wheel size 26"								
Wheel Gap											
<input checked="" type="checkbox"/> XY460	Rear wheel gap										
<input type="checkbox"/> 15	<input type="checkbox"/> 20	<input type="checkbox"/> 25									
<div style="border: 1px solid black; width: 100px; height: 20px; margin: 0 auto;"></div> mm											
Wheel Options (Choose one)											
<input type="checkbox"/> XK010	Wheel Sun Fusion 16 spoke daily use	<input type="radio"/> XK320	Wheel Spinerger XLX 12 spoke cross spoked daily (select colour below) \$ 849.00								
<input type="radio"/> XK050	Wheel Spinerger LX 12 spoke daily use (select colour below) \$ 796.00	<input type="radio"/> XK060	Wheel Spinerger SPOX 18 spoke daily (select colour below) \$ 530.00								
<input type="radio"/> XK210	Wheel Topolino carbon core with red accents \$ 1,591.00 (24", 25" only)	<input type="radio"/> XK070	Wheel Spinerger BLXL 18 blade spoke daily, rivnut handrim mounting (select colour below - Note: Black hub only) \$ 849.00								
<div style="display: flex; justify-content: space-between;"> <div style="width: 45%;"> <p>i Spinerger Colour Options</p> <table style="width: 100%; border: none;"> <tr> <td><input type="checkbox"/> Black spoke / Silver hub</td> <td><input type="checkbox"/> White spoke / Black Hub</td> </tr> <tr> <td><input type="checkbox"/> Red spoke / Black hub</td> <td><input type="checkbox"/> Blue spoke / Black hub</td> </tr> <tr> <td><input type="checkbox"/> Yellow spoke / Black hub</td> <td><input type="checkbox"/> Green spoke / Black hub</td> </tr> <tr> <td><input type="checkbox"/> Pink spoke / Black hub</td> <td><input type="checkbox"/> Orange spoke / black hub</td> </tr> </table> </div> <div style="width: 45%;"> <p><input type="radio"/> XK180 Spinerger spoke colour custom (Specify below) \$ 170.00</p> <div style="border: 1px solid black; padding: 2px; margin-bottom: 5px;"> <p style="font-size: x-small; margin: 0;">Colour inside i</p> <p style="font-size: x-small; margin: 0;">Colour outside i</p> </div> <p style="font-size: x-small; margin-top: 5px;">Note: Supply picture for custom designs</p> </div> </div>				<input type="checkbox"/> Black spoke / Silver hub	<input type="checkbox"/> White spoke / Black Hub	<input type="checkbox"/> Red spoke / Black hub	<input type="checkbox"/> Blue spoke / Black hub	<input type="checkbox"/> Yellow spoke / Black hub	<input type="checkbox"/> Green spoke / Black hub	<input type="checkbox"/> Pink spoke / Black hub	<input type="checkbox"/> Orange spoke / black hub
<input type="checkbox"/> Black spoke / Silver hub	<input type="checkbox"/> White spoke / Black Hub										
<input type="checkbox"/> Red spoke / Black hub	<input type="checkbox"/> Blue spoke / Black hub										
<input type="checkbox"/> Yellow spoke / Black hub	<input type="checkbox"/> Green spoke / Black hub										
<input type="checkbox"/> Pink spoke / Black hub	<input type="checkbox"/> Orange spoke / black hub										
<input type="radio"/> XK190	Spinerger black hub with black spokes \$ 96.00	<input type="radio"/> XK200	Spinerger silver hub with coloured spokes \$ 101.00								
<input type="radio"/> XK040	Wheel omit / supply without - \$ 212.00 (Specify wheel type / size / tyre)	i <div style="border: 1px solid black; width: 200px; height: 20px; display: inline-block;"></div>									
Handrim Positon											
<input type="checkbox"/>	Handrim set narrow (Standard if no opton selected)	<input type="checkbox"/>	Handrim set wide								
Handrim Options											
<input type="checkbox"/> XL010	Handrim aluminium hard anodised 6 tab (Standard if No opton selected)	<input type="radio"/> XL040	Handrim ttanium 6 tab \$ 355.00								
<input type="radio"/> XL030	Handrim surge LT 6 tab \$ 499.00	<input type="radio"/> XL050	Handrim stainless steel 6 tab \$ 197.00								
<input type="radio"/> XL020	Handrim tetra grip 6 tab \$ 318.00	<input type="radio"/> XL090	Handrim remove excess mounting tab \$ 116.00 (Recommended when XY460 is 20mm or less) (Narrow set only)								
<input type="radio"/> XL100	Handrim para grip 6 tab \$ 318.00										
Tyre Options											
<input type="checkbox"/> XM010	Kenda Tyre High Pressure	i <input type="checkbox"/> Grey	<input type="checkbox"/> Blue <input type="checkbox"/> Red								
<input type="radio"/> XM130	Kenda black \$ 22.00	(Standard if no opton selected)									
<input type="radio"/> XM020	Tyre Schwalbe Marathon Plus \$ 79.00	<input type="radio"/> XM060	Tyre Schwalbe One (24",25" only) \$ 106.00								
<input type="radio"/> XM040	Tyre Shox solid airless black only \$ 128.00 (24",25" only)	<input type="radio"/> XM050	Tyre Kenda K885 mountain bike tyre \$ 32.00 (24",25" only)								
Inner Tube Valve Options											
<input type="checkbox"/> XY500	Schraeder inner tube valve (Standard if no opton selected)	<input type="checkbox"/> XY490	Presta inner tube valve								
 											
Wheel Accessories											
<input type="radio"/> XK220	Wheel ttanium quick release axle pin (pair) \$ 128.00 (N/A with XK010 & XK070)	<input type="radio"/> XK300	Ofroad wheel set 22" rim with handrim, MTB tyre and axle pins (Replaces 24" wheel with XM010) \$ 743.00								
<input type="radio"/> XK240	Wheel quad release axle nut (pair) \$ 191.00	<input type="radio"/> XK310	Ofroad wheel set 24" rim with handrim, MTB tyre and axle pins (Replaces 25" wheel with XM010) \$ 743.00								
<input type="radio"/> XK250	Wheel transparent polycarbonate spokeguard (pair) \$ 143.00										

FRAME FINISH OPTIONS		
Frame	Components	
<input type="checkbox"/> XN010 Finish frame powder coated <i>(Includes H-frame)</i> <input type="checkbox"/> Specify Code <input style="width: 100px; height: 20px;" type="text"/> <input type="radio"/> FXAXN030 Finish frame brushed aluminium \$ 170.00 <input type="radio"/> FXAXN050 Finish frame polished aluminium \$ 530.00	<input type="checkbox"/> XN150 Finish components powder coated <i>(Camber bar & sideguards) (Standard black if not Indicated)</i> <input type="checkbox"/> Specify Code <input style="width: 100px; height: 20px;" type="text"/> <input type="radio"/> XN160 Finish components brushed \$ 96.00 <i>(Camber bar & sideguards)</i> <input type="radio"/> XN170 Finish components polished \$ 170.00 <i>(Camber bar & sideguards)</i>	
Accent Colour (Choose One)		
<input type="checkbox"/> Finish accent colour black <input type="checkbox"/> Finish accent colour red <input type="checkbox"/> Finish accent colour purple	<input type="checkbox"/> Finish accent colour silver <input type="checkbox"/> Finish accent colour blue	
UPHOLSTERY		
Seat Upholstery		
<input type="checkbox"/> XP040 Upholstery seat sling adjustable tension with straps <i>(Standard if not indicated)</i>	<input type="radio"/> XR050 Accessory carbon fibre seat plate in lieu of seat upholstery \$ 382.00	
Backrest Upholstery		
<input type="checkbox"/> XP050 Upholstery backrest Airtech adjustable tension with straps <i>(Standard if not indicated)</i>		
Backrest Upholstery Leather Options		
<input type="radio"/> XP060 Upholstery backrest upgrade to full leather \$ 398.00		
<input type="checkbox"/> Leather colour black <i>(Standard if not indicated)</i>	<input type="checkbox"/> Leather colour red	<input type="checkbox"/> Leather colour grey
<input type="radio"/> XP070 Upholstery upgrade to leather corners on side wings - <i>(N/A with XG080)</i> \$ 96.00		
<input type="checkbox"/> Leather colour black <i>(Standard if not indicated)</i>	<input type="checkbox"/> Leather colour red	<input type="checkbox"/> Leather colour grey
Backrest Upholstery Sttching Options		
<input type="checkbox"/> Silver (Standard if not indicated)	<input type="checkbox"/> Black	<input type="checkbox"/> Blue
<input type="checkbox"/> Red	<input type="checkbox"/> Light blue	<input type="checkbox"/> Purple
Backrest Upholstery Logo Options		
<input type="checkbox"/> Silver (Standard if not	<input type="checkbox"/> Black	<input type="checkbox"/> Blue
<input type="checkbox"/> Red	<input type="checkbox"/> Light blue	<input type="checkbox"/> Purple
Backrest Accessories		
<input type="radio"/> XP110 Upholstery backrest with zip fasten pocket \$ 101.00	<input type="radio"/> XP170 Upholstery with individual embroidery \$ 160.00 <i>(please provide .jpeg file and positoning)</i>	

CUSHION

- XP080 Upholstery cushion foam with nylon cover
 \$ 96.00
- Cushion foam sof (CMS040)
 - Cushion thickness 50mm
- Cushion foam medium (CMS050)
- Cushion thickness 75mm
- Cushion foam hard (9lb recon)
- Cushion thickness 100mm
- XP090 Upholstery cushion cover upgrade to Air Lite
 \$ 79.00
- XP100 Upholstery cushion cover upgrade to leather
 \$ 202.00
- Leather colour black
 - Leather colour red
 - Leather colour grey

FRAME OPTIONS

- XR080 Accessory front wheel assembly
 \$ 838.00
 Frontwheel serial number
 (Ofce use only)

ACCESSORIES

- XR010 Accessory seat pouch velcro atach
 \$ 47.00 (Black standard)
- XR100 Accessory FX carry bag
 \$ 266.00
- XR090 Accessory toolkit
- XS060 Accessory calf strap

