

49 Bespoke Inc. 51 Caldari Road, Units 6-7B  
Concord, ON L4K 4G3 Canada  
T: (416) 661-4499 F: (416) 661-8903

Telephone: +1.866.827.4548  
Fax: +1.877.731.7745  
49@49Bespoke.com

Distributor Name:	_____
Contact Name:	_____
Address:	_____ _____
Postcode:	_____
Country:	_____
Telephone:	_____
Email:	_____

Dealers Name:	_____
Client's Name:	_____
Client's Weight:	_____
Client's Height:	_____
Client's Disability:	_____ _____

Purchase Order No:	_____
Delivery Address:	_____ _____ _____
Postcode:	_____
Contact Name:	_____
Telephone:	_____
Email:	_____

Notes/Comments:
-----------------

Do Not Use for Specification Information

**FOR RGK OFFICE USE ONLY**

Distributor:	_____
A/C No:	_____ _____

Net Value:	_____
Freight:	_____
Invoice Value:	_____
Payment Received:	_____

	Who	Date
OK to Quote:		
OK to Confirm:		
Document No:	DOC	

- Base Product
- Standard Configuration
- Mandatory Information
- Option with No extra cost
- Information Required for Option
- Option with Extra cost

TMLXZ010 Maxlite Titanium  
\$5750.00

XA080 Frame closed design

Max User Weight 100kg

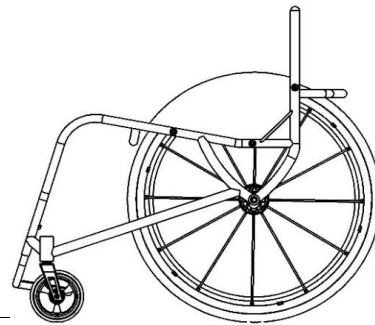

XW010 CAD drawing for approval

### KEY FRAME MEASUREMENTS

- XY010 Seat width *(Inside of sideguards)*  
 mm *(Max - 440mm)*  
 *(Min - 250mm)*
- XY020 Seat length  
 mm *(Max - 440mm)*  
 *(Min - 250mm)*
- XY030 Seat frame additional length *(Provides additional leg support & hand grip)*  
 mm *(Information icon)*
- XY050 Front frame height  
 mm *(Max - 550mm)*  
 *(Min - 380mm)*
- XY060 Rear frame height  
 mm *(Max - 550mm)*  
 *(Min - 360mm)*
- XY070 Frame length  
 mm *(Max - 650mm)*  
 *(Min XY020 + XY030 + 110mm)*
- XA020 Frame ergonomic seat \$93.00  
 mm *(Specify length)*  
 *(Standard = 120mm)*

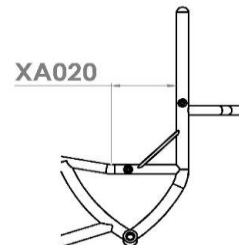
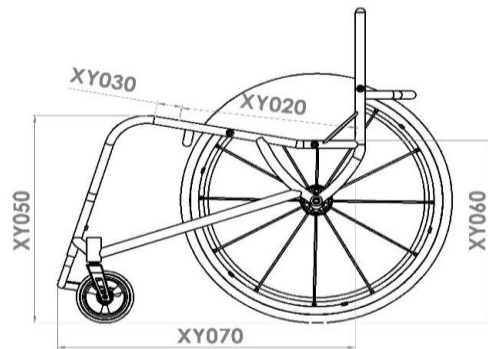
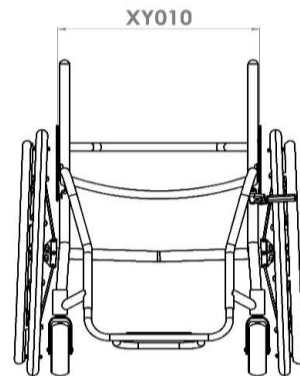

## FRONT FRAME AND FOOTREST

### Front Frame Options

- XY080 Front seat taper design

Specify width  mm

(Optional, To provide additional leg support / positioning)

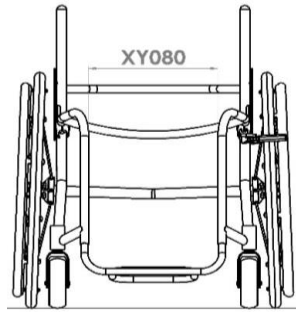

- Footrest width

Specify width  mm

(When combined with XY080, Dimensions must be smaller)

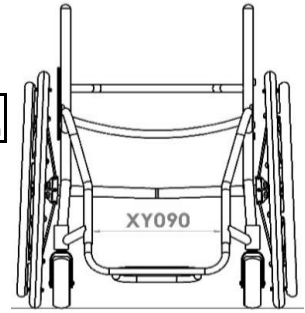

### Footrest Design & Measurements (Choose One)

- XY100 Footrest round design (Minimum 60mm)

Please indicate front footrest height:

60  80  100  120  
 Individual  mm

- XB200 Footrest with high level riser system (Only with \$155.00 XB010, XB080 & XB150)

- XY105 Footrest square design (Square design allows higher position) (Minimum 60mm)

Please indicate front footrest height:

60  80  100  120  
 Individual  mm

- XB200 Footrest with high level riser system (Only with \$155.00 XB010, XB080 & XB150)

### Footrest Individual Measurements

Rear footrest height

mm

- Optimise measurements (Standard = Footrest height - 20mm)

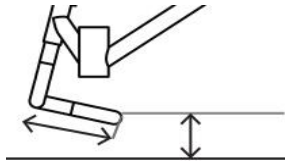

Footrest length

mm (max - 140mm)

- Optimise measurements (Standard = 100mm)

### Footrest Style (Choose One)

- XB020 Footrest height adjustable tubular titanium

- XB030 Footrest height and angle adjustable flip up left and right (Not with XA070) \$273.00

- XB070 Footrest height & angle adjustable aluminium plate \$160.00

- XB150 Footrest height adjustable tubular heavy duty \$139.00

- TMLXB080 Footrest fixed position welded into frame \$130.00

### Footrest Cover

- XB050 Footrest cover carbon fibre (Not XB070 & XB030) \$191.00

- XB170 Footrest cover - aluminium (Not XB070 & XB030) \$77.00

- XB040 Footrest cover - ABS (Not XB070 & XY030) \$77.00

- XB160 Footrest grip tape fitted to any footrest cover (Standard with XB070, not XB030) \$41.00

## CASTOR WHEELS, FORKS & WHEEL LOCKS

### Castor Wheels

3"

- XC150 Castor wheel 3x1.4" aluminium centre frog legs  
\$180.00 (Silver hub and black urethane tyre)

4"

- XC060 Castor wheel 4x1.3" soft roll black
- XC110 Castor wheel 4x1" aluminium centre frog legs (Silver hub & black urethane tyre)  
\$180.00
- XC130 Castor wheel 4x1.4" aluminium centre with urethane tyre frog legs  
\$180.00 Choose colour below (XC130 Only) :

- |  |  |  |   |
|--|--|--|---|
| <input type="checkbox"/> Silver hub & black tyre (Std) | <input type="checkbox"/> Black hub & blue tyre | <input type="checkbox"/> Purple hub & black tyre | <input type="checkbox"/> Silver hub & blue tyre |
| <input type="checkbox"/> Black hub & black tyre        | <input type="checkbox"/> Red hub & black tyre  | <input type="checkbox"/> Gold hub & black tyre   | <input type="checkbox"/> Silver hub & red tyre  |
| <input type="checkbox"/> Black hub & red tyre          | <input type="checkbox"/> Blue hub & black tyre | <input type="checkbox"/> Green hub & black tyre  |   |

5"

- XC070 Castor wheel 5x1.3" soft roll black
- XC100 Castor wheel 5" pneumatic aluminium centre  
\$191.00
- XC120 Castor wheel 5x1" aluminium centre frog legs (Silver hub & black urethane tyre)  
\$180.00
- XC140 Castor wheel 5x1.4" aluminium centre frog legs (Silver hub & black urethane tyre)  
\$180.00

Choose one castor option only

### Castor Forks

- |   |  |   |
|---|--|---|
| <input type="checkbox"/> XC190 Castor fork low ride daily use<br>(Standard when no option selected) | <input type="radio"/> XC210 Castor fork suspension<br>\$489.00 frog legs | <input type="radio"/> XC220 Castor fork single sided uni<br>\$191.00 tine frog legs |
| <input type="checkbox"/> Black <input type="checkbox"/> Silver                                      | <input type="checkbox"/> Black <input type="checkbox"/> Silver           | <input type="checkbox"/> Black <input type="checkbox"/> Silver                      |

### Castor Pin Width

- XY330 Castor pin width
- mm
- Optimise measurements  
(Minimum width for clear castor rotation and maximum wheelbase length)

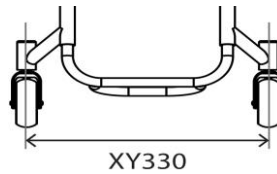

### Wheel Lock Options

#### Scissor

- XD020 Wheel locks underseat scissor
- XD040 Wheel locks scissor levers drilled  
\$57.00
- XD030 Wheel locks compact scissor  
\$206.00

#### Other

- XD050 Wheel locks push to lock
- XD010 Wheel locks omit

## SIDEGUARDS AND ARMRESTS

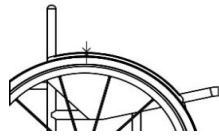
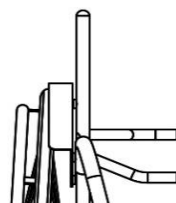
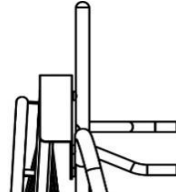
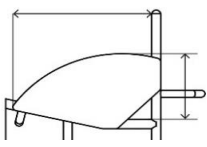
Sideguard		Sideguard with Fender	
Aluminium Options		Aluminium Options	
<input type="radio"/>	XE030 Sideguards screw on aluminium \$252.00	<input type="radio"/>	XE040 Sideguards screw on aluminium with fender \$216.00
<input type="radio"/>	XE080 Sideguards lift out aluminium \$412.00	<input type="radio"/>	XE090 Sideguards lift out aluminium with fender \$488.00
<input type="radio"/>	XE180 Sideguards flip back aluminium \$304.00	<input type="radio"/>	XE190 Sideguards flip back aluminium with fender \$258.00
Carbon Fibre Options		Carbon Fibre Options	
<input type="radio"/>	XE050 Sideguards screw on carbon fibre \$561.00	<input type="radio"/>	XE060 Sideguards screw on carbon fibre with fender \$736.00
<input type="radio"/>	XE100 Sideguards lift out carbon fibre \$592.00	<input type="radio"/>	XE110 Sideguards lift out carbon fibre with fender \$876.00
<input type="radio"/>	XE200 Sideguards flip back carbon fibre \$464.00	<input type="radio"/>	XE210 Sideguards flip back carbon fibre with fender \$577.00
ABS Plastic Options		Sideguard Measurements	
<input type="radio"/>	XE070 Sideguards screw on ABS plastic \$129.00	Optimised measurements	
<input type="radio"/>	XE120 Sideguards lift out ABS plastic \$376.00	<p>Fender sideguard height above tyre (Min = 10mm)</p> <div style="display: flex; align-items: center;"> <div style="margin-right: 20px;"> <input type="checkbox"/> <input style="width: 100px; height: 20px; border: 1px solid black;" type="text"/> mm                 </div> <div style="text-align: center;">  </div> </div> <p><input type="checkbox"/> Optimise (10mm above tyre)</p>	
Welded Options		Individual measurements	
<input type="radio"/>	TMLXE220 Sideguards welded with 6mm bead \$385.00	<input type="checkbox"/> Fender sideguard to centre of tyre (Standard if no option selected)	
<input type="radio"/>	TMLXE240 Sideguards welded sport (Extra strong) \$495.00	<input type="checkbox"/> Fender sideguard to outside of tyre	
Armrest Options		Choose optimised or individual measurements	
<input type="radio"/>	XF010 Armrest fixed height, lift out with plastic sideguard \$458.00 (Indicate height)		
<input type="radio"/>	XF020 Armrest fixed height, lift out with aluminium sideguard \$361.00 (Indicate height)		
<p>Height (Top of seatrail to top of armrest)</p> <div style="display: flex; align-items: center;"> <div style="margin-right: 10px;"><input type="checkbox"/></div> <div style="border: 1px solid black; width: 100px; height: 20px; display: flex; align-items: center; justify-content: center;"> <span style="font-size: 8px;">mm</span> </div> </div>			
Sideguard Measurements		Choose optimised or individual measurements	
Optimised measurements			
<input type="checkbox"/>	Sideguard 25mm above tyre (Follow tyre - Std if not indicated)	Choose optimised or individual measurements	
<input type="checkbox"/>	Sideguard individual above tyre (Follow tyre)		
<input type="checkbox"/>	Sideguard level with tyre (Follow tyre)		
<p>Sideguard length</p> <div style="display: flex; align-items: center;"> <div style="margin-right: 20px;"> <input style="width: 100px; height: 20px; border: 1px solid black;" type="text"/> mm                 </div> <div style="text-align: center;">  </div> </div>		Choose optimised or individual measurements	
<p>Sideguard height</p> <div style="display: flex; align-items: center;"> <div style="margin-right: 20px;"> <input style="width: 100px; height: 20px; border: 1px solid black;" type="text"/> mm                 </div> </div>			

## BACKREST

### Backrest Height - Fixed or Adjustable (Choose One)

Backrest height fixed

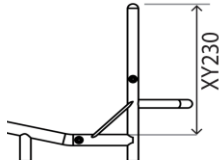

Specify height

 mm



XY245  
\$191.00

Backrest height adjustable  
(Upward range 50mm)

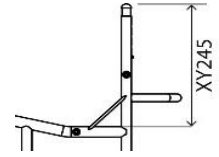

Indicate lowest height

 mm

### Backrest Design - Fixed or Folding (Choose One)

XG010 Backrest fixed (Non-folding)

TMLXG020 Backrest folding with 2 position snap lock and angle adjust ( $\pm 5$  Deg)

### Ergonomics - Rearward Positioning (Choose One)



XY360 Backrest angle

 -5  -3  0  +3  +5

Individual  Deg  
(Max -10/+20 Deg)

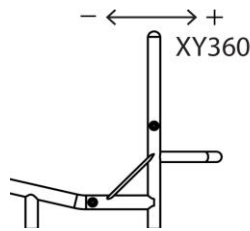



XG100 Backrest ergonomic  
\$113.00



Vertical height (Min 250mm)

 mm

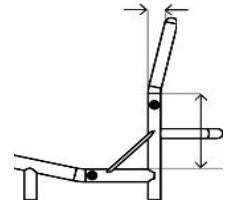
Rearward position

 mm

### Ergonomics - Lateral Positioning (Choose One)

XG110 Backrest inward taper  
\$113.00 (Above sideguards)

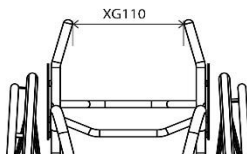

Width

 mm



XG120 Backrest outward flare  
\$113.00 (Above sideguards)

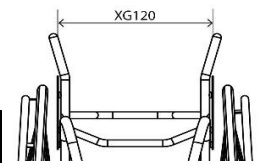

Width

 mm

### Push handle Options

XG070 Backrest with screw in push handles (N/A with XY245)  
\$175.00

XG080 Backrest with flip down push handles (N/A with XY245)  
\$340.00

XG085 Backrest with flip down push handles height adjustable (N/A with XY245)  
\$556.00

XG090 Backrest with height adjustable push handles  
\$340.00



Height from floor

 mm

Optimise  
(1000mm from floor)

### Backrest Options

XG040 Backrest fixed heavy duty (Recommended for hand cycling) (N/A with XY245)  
\$160.00







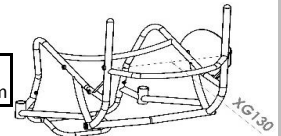



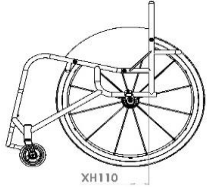

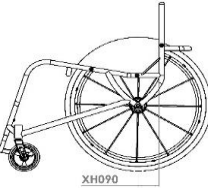
XG130 Backrest brace tube extra deep (Standard - 90mm)  
\$88.00

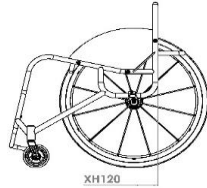

Depth

 mm

**CAMBER BAR**



Adjustable Centre of Gravity		Fixed Centre of Gravity	
Centre of gravity - Choose one	<input type="checkbox"/> <b>XH110</b> Camber bar adjustable position square back frame (25-150mm) <i>(Open or closed frame)</i>  XH110  <input style="width: 100px;" type="text"/> mm	Centre of gravity - Choose one	<input type="radio"/> <b>TMLXH090</b> \$340.00 Camber bar fixed position integrated into frame V design (25-125mm) <i>(Open or closed frame)</i>  XH090  <input style="width: 100px;" type="text"/> mm
	<input type="checkbox"/> <b>XH120</b> Centre of gravity adjustable round back frame (60-150mm) <i>(Open or closed frame)</i>  XH120  <input style="width: 100px;" type="text"/> mm		
Specify Camber Angle		Specify Camber Angle	
	<input checked="" type="checkbox"/> <b>XY390</b> Camber angle  <input type="checkbox"/> 0 <input type="checkbox"/> 1 <input type="checkbox"/> 2 <input type="checkbox"/> 3 <input type="checkbox"/> 5		<input checked="" type="checkbox"/> <b>XY390</b> Camber angle  <input type="checkbox"/> 0 <input type="checkbox"/> 1 <input type="checkbox"/> 2 <input type="checkbox"/> 3 <input type="checkbox"/> 5
Camber Bar Options		Camber Bar Options	
	<input type="radio"/> <b>XH030</b> \$659.00 Suspension camber bar frog legs  <input type="radio"/> <b>XH040</b> \$309.00 Handbike camber bar fixed welded  Camber angle ( <i>Handbike camber bar</i> )  <input type="checkbox"/> 0 <input type="checkbox"/> 5  Castor height from floor for handbike fitting <i>(Standard 30mm if not indicated)</i>  <input type="checkbox"/> 30 <input type="checkbox"/> 50		<input type="radio"/> <b>XH040</b> \$309.00 Handbike camber bar fixed welded  Camber angle ( <i>Handbike camber bar</i> )  <input type="checkbox"/> 0 <input type="checkbox"/> 5  Castor height from floor for handbike fitting <i>(Standard 30mm if not indicated)</i>  <input type="checkbox"/> 30 <input type="checkbox"/> 50
Anti-Tip Options			
	<input type="radio"/> <b>XJ010</b> \$129.00 Anti tip swingaway left side ( <i>Only with square back frame. Not with XH040</i> )		<input type="radio"/> <b>XJ020</b> \$129.00 Anti tip swingaway right side ( <i>Only with square back frame. Not with XH040</i> )

REAR WHEELS			
Wheel Size			
<input type="checkbox"/> XY420 Wheel size 24"	<input type="checkbox"/> XY430 Wheel size 25"	<input type="checkbox"/> XY440 Wheel size 26"	
Wheel Gap			
<input checked="" type="checkbox"/> XY460 Rear wheel gap <div style="display: flex; align-items: center; margin-top: 5px;"> <div style="margin-right: 10px;"> <input type="checkbox"/> 15  <input type="checkbox"/> 20  <input type="checkbox"/> 25                 </div> <div style="border: 1px solid black; width: 100px; height: 20px; display: flex; align-items: center; justify-content: center;">                     Individual _____ mm                 </div> </div>			
Wheel Options (Choose one)			
<input type="checkbox"/> XK010 Wheel Sun Fusion 16 spoke daily use <input type="radio"/> XK050 Wheel Spinergy <b>LX</b> 12 spoke daily use \$773.00 <i>(select colour below)</i> <input type="radio"/> XK070 Wheel Spinergy <b>BLXL</b> 18 blade spoke daily, rivnut handrim mounting <i>(select colour below, black hub only)</i> \$824.00	<input type="radio"/> XK320 Spinergy <b>XLX</b> 12 spoke cross spoked daily \$824.00 <i>(select colour below)</i> <input type="radio"/> XK060 Wheel Spinergy <b>SPOX</b> 18 spoke daily <i>(select colour below)</i> \$515.00		
Spinergy Colour Options			
<input type="checkbox"/> Black spoke / Silver hub <input type="checkbox"/> Red spoke / Black hub <input type="checkbox"/> Yellow spoke / Black hub <input type="checkbox"/> Pink spoke / Black hub <input type="radio"/> XK190 Spinergy black hub with black spokes \$93.00	<input type="checkbox"/> White spoke / Black Hub <input type="checkbox"/> Blue spoke / Black hub <input type="checkbox"/> Green spoke / Black hub <input type="checkbox"/> Orange spoke / black hub	<input type="radio"/> XK180 Spinergy spoke colour custom \$165.00 <i>(Specify below)</i> <div style="display: flex; align-items: center;"> <div style="margin-right: 10px;"> <input type="radio"/> Colour inside  <input type="radio"/> Colour outside                 </div> <div style="border: 1px solid black; width: 100px; height: 40px; display: flex; align-items: center; justify-content: center;">                     _____                 </div> </div> <p style="font-size: small; margin-top: 5px;">Note: Supply picture for custom designs</p> <input type="radio"/> XK200 Spinergy silver hub with coloured spokes \$98.00	
<input type="radio"/> XK040 Wheel omit / supply without <del>-\$206.00</del> <i>(Specify wheel type / size / tyre)</i>	<input style="width: 100%;" type="text"/>		
Handrim Position			
<input type="checkbox"/> Handrim set narrow <i>(Standard if no option selected)</i>	<input type="checkbox"/> Handrim set wide		
Handrim Options			
<input type="checkbox"/> XL010 Handrim aluminium hard anodised 6 tab <i>(Standard if No option selected)</i> <input type="radio"/> XL030 Handrim surge LT 6 tab \$484.00 <input type="radio"/> XL020 Handrim tetra grip 6 tab \$309.00 <input type="radio"/> XL100 Handrim para grip 6 tab \$309.00	<input type="radio"/> XL040 Handrim titanium 6 tab \$345.00 <input type="radio"/> XL050 Handrim stainless steel 6 tab \$191.00 <input type="radio"/> XL090 Handrim remove excess mounting tab \$113.00 <i>(Recommended when XY460 is 20mm or less) (Narrow Set Only)</i>		
Tyre Options			
<input type="checkbox"/> XM010 Kenda Tyre High Pressure <input type="radio"/> XM130 Kenda black \$21.00 <input type="radio"/> XM020 Tyre Schwalbe Marathon Plus \$77.00 <input type="radio"/> XM040 Tyre Shox solid airless black only \$124.00 <i>(24",25" only)</i>	<input checked="" type="checkbox"/> Grey <i>(Standard if no option selected)</i> <input type="checkbox"/> Blue <input type="checkbox"/> Red <input type="radio"/> XM060 Tyre Schwalbe One <i>(24",25" only)</i> \$103.00 <input type="radio"/> XM050 Tyre Kenda K885 mountain bike tyre \$31.00 <i>(24",25" only)</i>		
Inner Tube Valve Options			
<input type="checkbox"/> XY500 Schraeder inner tube valve <i>(Standard if no option selected)</i>	<input type="checkbox"/> XY490 Presta inner tube valve		
Wheel Accessories			
<input type="radio"/> XK220 Wheel titanium quick release axle pin <i>(pair)</i> \$124.00 <i>(N/A with XK010 &amp; XK070)</i> <input type="radio"/> XK240 Wheel quad release axle nut <i>(pair)</i> \$185.00 <input type="radio"/> XK250 Wheel transparent polycarbonate spokeguard <i>(pair)</i> \$139.00	<input type="radio"/> XK300 Offroad wheel set 22" rim with handrim, MTB tyre and axle pins <i>(Replaces 24" wheel with XM010)</i> \$721.00 <input type="radio"/> XK310 Offroad wheel set 24" rim with handrim, MTB tyre and axle pins <i>(Replaces 25" wheel with XM010)</i> \$721.00		



FRAME FINISH OPTIONS		
Frame	Components	
<input type="checkbox"/> XN010 Finish frame powder coated <i>(Includes H-frame)</i>	<input type="checkbox"/> XN150 Finish components powder coated <i>(Footrest, camber bar &amp; sideguards) (Standard black if not Indicated)</i>	
(i) Specify Code <input style="width: 100px;" type="text"/>	(i) Specify Code <input style="width: 100px;" type="text"/>	
<input type="radio"/> TMLXN030 Finish frame brushed \$155.00	<input type="radio"/> XN160 Finish components brushed <i>(Footrest, camber bar &amp; sideguards)</i> \$93.00	
<input type="radio"/> TMLXN050 Finish frame polished \$485.00	<input type="radio"/> XN170 Finish components polished <i>(Footrest, camber bar &amp; sideguards)</i> \$165.00	
UPHOLSTERY		
Seat Upholstery		
<input type="checkbox"/> XP040 Upholstery seat sling adjustable tension with straps <i>(Standard if not indicated)</i>	<input type="radio"/> XR050 Accessory carbon fibre seat plate in lieu of seat upholstery \$371.00	
Backrest Upholstery		
<input type="checkbox"/> XP050 Upholstery backrest Airtech adjustable tension with straps <i>(Standard if not indicated)</i>		
Backrest Upholstery Leather Options		
<input type="radio"/> XP060 Upholstery backrest upgrade to full leather \$386.00		
<input type="checkbox"/> Leather colour black <i>(Standard if not indicated)</i>	<input type="checkbox"/> Leather colour red	<input type="checkbox"/> Leather colour grey
<input type="radio"/> XP070 Upholstery upgrade to leather corners on side wings - <i>(N/A with XG080)</i> \$93.00		
<input type="checkbox"/> Leather colour black <i>(Standard if not indicated)</i>	<input type="checkbox"/> Leather colour red	<input type="checkbox"/> Leather colour grey
Backrest Upholstery Stitching Options		
<input type="checkbox"/> Silver <i>(Standard if not indicated)</i>	<input type="checkbox"/> Black	<input type="checkbox"/> Blue
<input type="checkbox"/> Red	<input type="checkbox"/> Light blue	<input type="checkbox"/> Purple
Backrest Upholstery Logo Options		
<input type="checkbox"/> Silver <i>(Standard if not indicated)</i>	<input type="checkbox"/> Black	<input type="checkbox"/> Blue
<input type="checkbox"/> Red	<input type="checkbox"/> Light blue	<input type="checkbox"/> Purple
Backrest Accessories		
<input type="radio"/> XP110 Upholstery backrest with zip fasten pocket \$98.00	<input type="radio"/> XP170 Upholstery with individual embroidery <i>(Please provide .jpeg file and positioning)</i> \$155.00	

**CUSHION**

- XP080 Upholstery cushion foam with nylon cover  
\$93.00
-  Cushion foam soft (CMS040)       Cushion foam medium (CMS050)       Cushion foam hard (9lb recon)
- Cushion thickness 50mm       Cushion thickness 75mm       Cushion thickness 100mm
- XP090 Upholstery cushion cover upgrade to Air Lite  
\$77.00
- XP100 Upholstery cushion cover upgrade to leather  
\$196.00
-  Leather colour black       Leather colour red       Leather colour grey

**FRAME OPTIONS**

- XR060 Accessory welded calf strap mounting loops  
\$118.00 (To locate calf strap on front frame)
- XR080 Accessory front wheel assembly (Only with XB010, XB080, XB150)  
\$814.00
- Frontwheel serial number  
 (Office use only)

**ACCESSORIES**

- XP420 Upholstery frame protectors nylon with velcro fasten  
\$62.00
- XR010 Accessory seat pouch velcro attach  
\$46.00 (Black)
- XR020 Accessory large underseat storage bag (Black)  
\$98.00
- XR090 Accessory toolkit
- XS060 Accessory calf strap



**NOTES**

A large rectangular area for taking notes, currently blank.

A large rectangular area with a grid pattern, intended for technical drawings or detailed notes.